

catalogo
2013-2014
brochure



BARRET®

ATTREZZATURE PER L'ALLENAMENTO DEI CAMPIONI
TRAINING TOOLS FOR CHAMPIONS



PARTNER OF
Milanello Training Centre
Technical Equipment



PARTNER COMMERCIALE



official supplier
F.C. Internazionale



official supplier
F.C. Internazionale





official supplier
F.C. Internazionale





F.C. Internazionale - Appiano Gentile Training Center



official supplier
F.C. Internazionale



official supplier
F.C. Internazionale



Centro Sportivo Milanello



Milanello Training Center

Centro Sportivo Milanello



Milanello Training Center

Centro Sportivo Milanello



Milanello Training Center

Centro Sportivo Milanello



Milanello Training Center

Centro Allenamento Calcio Catania



PARTNER COMMERCIALE



Calcio Catania Training Center

Centro Allenamento Calcio Catania



PARTNER COMMERCIALE



Calcio Catania Training Center

Centro Allenamento Calcio Catania



PARTNER COMMERCIALE



Calcio Catania Training Center

Centro Allenamento Calcio Catania



PARTNER COMMERCIALE



Calcio Catania Training Center



Allenatore Giovanni Trapattoni
Assistente Allenatore Marco Tardelli
Preparatore Atletico Fausto Rossi

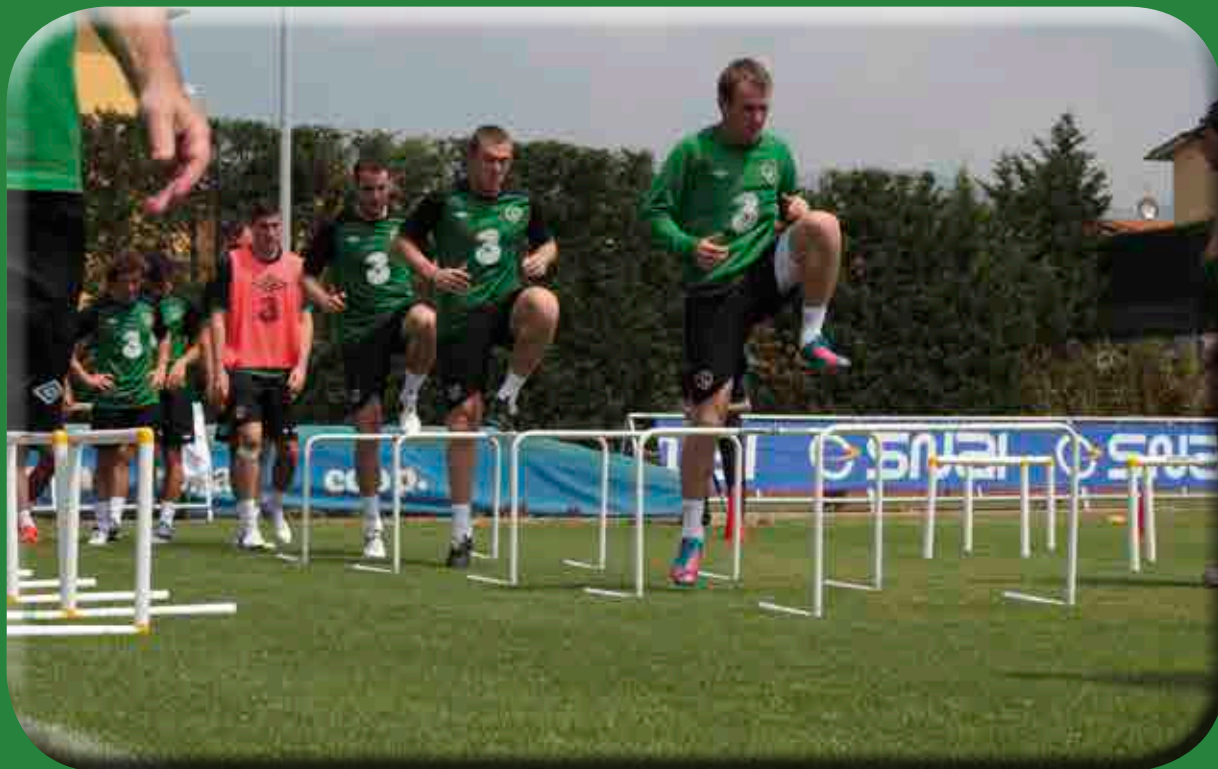

**Nazionale Irlandese di Calcio
Irish National Team**



**Coach Giovanni Trapattoni
Assistant Coach Marco Tardelli
Physical Trainer Fausto Rossi**



Nazionale Irlandese di Calcio
Irish National Team





**Real Zaragoza S.A.D.
Ciudad Deportiva**





**Real Zaragoza S.A.D.
Ciudad Deportiva**





**Real Zaragoza S.A.D.
Ciudad Deportiva**





**Real Zaragoza S.A.D.
Ciudad Deportiva**



I PRODOTTI BARRET SONO DIVENUTI STRUMENTI INDISPENSABILI NON SOLO PER LA PREPARAZIONE TECNICA E ATLETICA DEGLI ATLETI PROFESSIONISTI MA ANCHE PER L'ALLENAMENTO DEI GIOCATORI DILETTANTI, DEGLI AMATORI E DEI RAGAZZI DELLE SCUOLE CALCIO E DEI SETTORI GIOVANILI.



A.S.D. Pro Livorno 1919 Sorgenti (Livorno)



**Real Madrid Summer Camp
Cecina 2009-2010-2011-2012**

**OFFERTA KIT TECNICO
SCUOLA CALCIO A PAG. 81
SOCCER SCHOOL KIT
OFFER @ PAGE 81**



BARRET PRODUCTS HAVE QUICKLY BECOME IMPORTANT TRAINING TOOLS NOT ONLY FOR PRO ATHLETES BUT ALSO FOR AMATEURS AND SOCCER SCHOOLS



U.S. Porta a Piage Settore Giovanile Scuola Calcio (Pisa)

**OFFERTA KIT TECNICO
SCUOLA CALCIO A PAG. 81
SOCCER SCHOOL KIT
OFFER @ PAGE 81**



Polisportiva Pallavolo Riotorto

INDICE

Attrezzature per la preparazione atletica e specifiche per il Calcio Training and Soccer equipment

Sagome - Mannequins.....	pag.	24-33
Barriera filtrante - Reflex Training Device	pag.	34
Paletti - Slalom Poles.....	pag.	35-37
Delimitatori e Birilli - Markers and Cones	pag.	38-42
Ostacoli ad altezza fissa e regolabile - Hurdles fixed and adjustable heights.....	pag.	43-52
Kit Calcio Tennis - Soccer Tennis kits.....	pag.	53-56
Archi di precisione - Precision Arcs	pag.	57
Forche - Heading Trellises	pag.	58-59
Muri e Telai con rete - Rebounders and Iron Frames with net	pag.	60-63
Deviatore di traiettoria, Ball Plaining - Deviator, Ball Plaining	pag.	64
Strutture instabili e Tavole Propriocettive, Plinti - Equilibrium Boards.....	pag.	65-69
Trampolini, Cerchi, Corde, Bastoni - Trampolines, Hoops, Jumping Cords, Sticks	pag.	70-71
Attrezzi speciali, Scale e Bande elastiche - Special Training tools, Speed Ladders and Elastic Bands.....	pag.	72-80
Kit tecnico Scuola Calcio - Soccer School kit.....	pag.	81
Fitness Equipment.....	pag.	82-89
Casacche, Pantaloncini, Calze, Giacche pioggia, Tubolare Barret, Numeri Termosaldabili, Parastinchi, Fasce Capitano, Guanti Portiere - Mesh Shirts, Shorts, Socks, Rain jackets, Tubular hat, Numbers for uniforms, Shinguards, Captain Armbands, GK Gloves	pag.	90-95
Protezioni - Protections.....	pag.	176-177
Tacchetti e accessori per scarpette, Lavascarpe - Studs and shoe accessories, Shoe Washing Device.....	pag.	96-98
Materassini - Mats	pag.	99
Lavagne Tattiche - Tactic Boards.....	pag.	100-101
Ghiaccio, Tape, Creme, Oli, Borracce - Ice, Tape, Creams, Oils, Water Bottles.....	pag.	102-104
Bandierine e accessori per arbitro - Flags and referee's accessories.....	pag.	105-107
Pompe, Compressori, Cronometri e Rotelle Metriche - Pumps, Inflators, Chronos.....	pag.	108-109
Segnalatori elettronici e manuali per cambio giocatori, Segnapunti - Substitution Boards	pag.	110-112
Palloni in pelle ed in gomma - Leather and rubber Balls	pag.	113-117
Palle Mediche, Ritmiche e Psicomotorie - Medicine, Rhythmic and Gym Balls.....	pag.	118-121
Borse - Bags.....	pag.	122-123
Ceste Portapalloni - Baskets for balls	pag.	124

Attrezzature per lo stadio e lo spogliatoio Stadium and locker room equipment

Porte regolamentari, ridotte, miniporte, porte bifrontali - Official goals, reduced goals, minigoals, 2 side goals .	pag.	125-133
Reti regolamentari e ridotte - Nets all sizes	pag.	134-135
Reti di Protezione - Protection Nets.....	pag.	136
Panchine Allenatori - Trainers' Dug-outs.....	pag.	138-144
Carrelli Traccia Linee, Vernice segnacampo - Line Markers, Ecological Paint	pag.	145-147
Scocche per tribune e Tribune modulari per interno ed esterno - Stadium seats and Stands	pag.	148-150
Arredi spogliatoio e infermeria - Locker and infirmary room	pag.	151-156
Tunnel uscita spogliatoi, Area Multisport - Stadium Tunnels, Multisport Area.....	pag.	157
Tabelloni elettronici segnapunti - Electronic scoreboards.....	pag.	178-179
Protezioni Murarie, Materassi - Wall Protections, Mats.....	pag.	195

Altri sport - other sports

Tavoli calcetto - Soccer tables	pag.	158
Basket.....	pag.	159-165
Volley	pag.	166-170
Minivolley.....	pag.	171
Beach Volley	pag.	172-173
Beach Soccer.....	pag.	137
Impianti Multifunzione - Multi purpose systems.....	pag.	174
Pallamano - Handball.....	pag.	175
Tennis, Beach Tennis	pag.	180-182
Tennis Tavolo - Table Tennis	pag.	183-185
Badminton.....	pag.	186
Rugby.....	pag.	187
Piscina, Pallanuoto - Swimming Pool, Waterpolo	pag.	188-189
Hockey, Baseball	pag.	190-191
Boxe, Arti Marziali - Boxe, Martial Arts	pag.	192-194
Ginnastica - Gymnastic.....	pag.	196-200
Atletica - Track and Field	pag.	201-204
Pilates, Didattica Scolastica, Pattini e Skateboard - Pilates, School Products, Skates	pag.	205-208

Barret Srl

Dal 1989 Barret Srl produce attrezzature tecniche per lo sport.

In particolare, l'Azienda si è affermata nel corso degli anni per la ideazione e realizzazione di strumenti di allenamento ormai divenuti indispensabili per la preparazione fisica, tecnica e tattica dei giocatori di Calcio, così come per la preparazione degli atleti di molti altri sport, sia di squadra che individuali.

Barret offre la più ampia varietà di attrezzature quali sagome, ostacoli, delimitatori, birilli, paletti per slalom, archi di precisione, kit per Calcio-Tennis, forche, bande elastiche, slitte, plinti, tavolette propriocettive, telai con rete, muri in vetroresina, miniporte, porte bifrontali, ridotte, regolamentari.

La qualità che distingue i prodotti offerti e le numerose innovazioni proposte con continuità nel corso degli anni hanno permesso all'Azienda di affermarsi non solo sul mercato italiano, ma anche su quello internazionale.

Barret ha sviluppato nel tempo una preziosa collaborazione con Milan ed Inter, fondamentale per permettere un interscambio di idee ed informazioni con i preparatori atletici della prima squadra e del settore giovanile, finalizzato al continuo miglioramento della funzionalità delle attrezzature tecniche per l'allenamento.

I prodotti Barret, infatti, vengono utilizzati quotidianamente sui campi di allenamento del Centro di Vinovo, di Milanello e di Appiano Gentile per coadiuvare la preparazione fisica e tecnica di alcuni tra i migliori giocatori di Calcio del mondo.

Sarebbe impresa ardua ricordare tutti i Club e le Nazionali che hanno scelto più volte di acquistare le nostre attrezzature per l'allenamento e per la gara attraverso la rete distributiva italiana ed estera.

Cogliamo l'occasione per ringraziare i preparatori atletici ed i responsabili acquisti di Arsenal, Barcellona, Bologna, Catania, Chelsea, Fiorentina, Inter, Juventus, Lazio, Milan, Lione, Liverpool, Manchester City, Manchester United, Monaco, Napoli, Palermo, Pescara, Reggina, Roma, Sampdoria, Udinese, Zenit e delle Nazionali di Calcio di Italia, Germania, Inghilterra e Irlanda.

Company Profile

Founded in 1989, Barret Srl produces all kinds of sport equipment and has established itself worldwide by devising and creating innovative tools which have become more and more important for improving tactical training and performances either of Soccer players or athletes practising other individual or team games.

Barret manufactures special products such as mannequins, hurdles, markers, cones, hoops, slalom poles, shooting arcs, Soccer-Tennis kits, heading trellises, elastic bands, sledges, vaulting boxes, equilibrium boards, iron frames with net, fiberglass rebounders, minigoals, reduced and regular goals.

The quality typical of tools and the variety of innovations introduced during the years have made Barret successful on both the Italian and the international market. Indeed, Barret develops its products also thanks to special partnerships with AC Milan and FC Internazionale Milano, two of the most prestigious Soccer Clubs in the world. The close relationship between Barret and their trainers has allowed a fruitful exchange of ideas and information, aimed at enhancing the functional capacity of technical equipment.

As a result, Barret tools are used every day at Vinovo, Milanello and Appiano Gentile camps to help athletic and technical training of some of the greatest Soccer players in the world.

It would be nearly impossible to name all professional Soccer Clubs and National Teams in Italy and Europe that have often chosen Barret equipment, purchasing training and competition tools through our distribution networks.

We take this opportunity to thank Clubs such as Arsenal, Barcellona, Bologna, Catania, Chelsea, Fiorentina, Inter, Juventus, Lazio, Milan, Lione, Liverpool, Manchester City, Manchester United, Monaco, Napoli, Palermo, Pescara, Reggina, Roma, Sampdoria, Udinese, Zenit and the Italian, English, German and Irish National Teams.

BARRET®

Le materie prime (i vari preparati plastici ed i profilati in polipropilene copolimero ed in pvc nei vari diametri, spessori e colori) utilizzate da BARRET per lo stampaggio e l'assemblaggio degli articoli in materiale plastico sono certificate dai nostri fornitori nel rispetto delle normative vigenti che impediscono l'utilizzo di sostanze ritenute tossiche per la salute dell'uomo e dell'ambiente.

Barret manufactures plastic products in pvc and polypropylene such as dummies, cones, markers, hurdles, slalom poles etc. using only certified non toxic raw materials not dangerous for human beings and the environment.

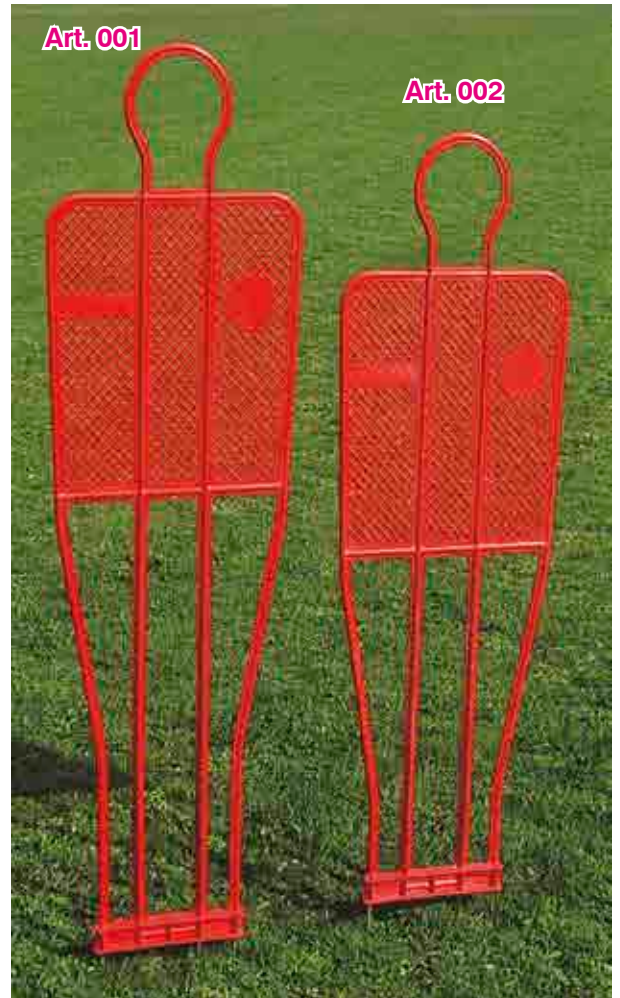

pg.1

**NUOVO MATERIALE PIU' FLESSIBILE!!!
NEW MORE ELASTIC PLASTIC MATERIAL!!!**



Art. 001
Sagoma Barret brevettata
cm. 180 Kg. 3,5
Patented Barret Mannequin
cm. 180 Kg. 3,5

Art. 002
Sagoma Barret brevettata
cm. 160 Kg. 3
Patented Barret Mannequin
cm. 160 Kg. 3

Colori:
Rosso, Blu e Giallo
Colors:
Red, Blue and Yellow

SAGOME BARRET BREVETTATE
leggere, flessibili, super-resistenti,
anti-infortunistiche!
PATENTED BARRET MANNEQUINS
light, flexible, strong, safe!

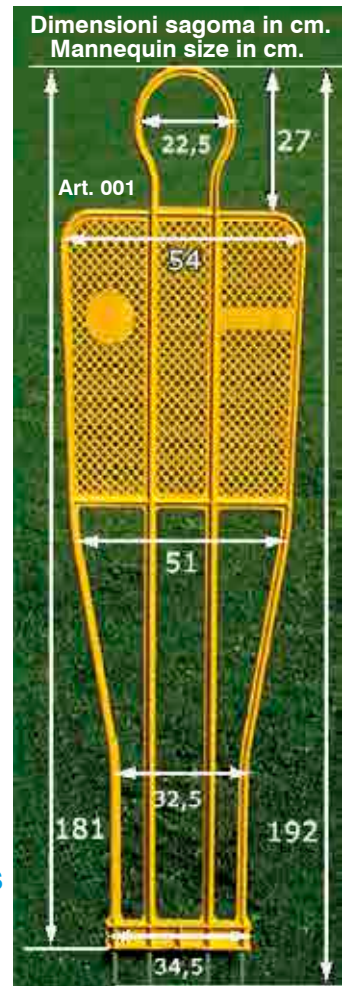

SAGOME BARRET

BARRET MANNEQUINS



3 x Art. 001 + 2 x Art. 002 + Art. 003
Carrello con 5 sagome - trolley + 5 Barret Mannequins

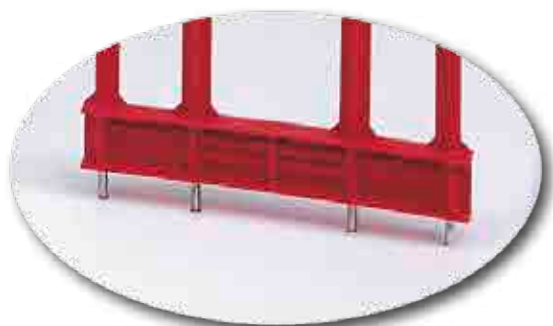

**4 puntali in acciaio zincato alla base
per posizionamento su
terreno naturale
o su carrello porta sagome**
4 galvanized steel spikes at the base,
for easy positioning on natural grass
or upon Barret trolley



Art. 003 Carrello porta 5 sagome in acciaio zincato con ruote
Trolley for carrying 5 Mannequins in galvanized steel, with wheels



SAGOME BARRET BREVETTATE
indispensabili per :
*calci di punizione, slalom, dribbling,
esercizi di anticipo, uscite aeree,
schemi tattici ...*

PATENTED BARRET MANNEQUINS
very useful for:
*free kicks, slalom, dribbling, tackles, headers,
goal-keeper exercises, tactics
and much, much more!!!*



pg.1

New!

BPS001

**BORSA PORTA 5 SAGOME in nylon impermeabile con tracolla e maniglie,
rinforzi laterali in polipropilene rigido**

Nylon carry bag for 5 dummies with shoulder belt and handles - waterproof - reinforced on both sides



Art. 003RG + 5x/Art. 001

pg.1



Art. 003RG

Carrello porta 5 sagome in ferro zincato su ruote - regolabile a 4 altezze (la sagoma 001 può arrivare ad un'altezza massima di cm.225)

Trolley for 5 mannequins in galvanized steel on wheels - 4 adjustable heights (Art. 001 can reach up to 225 cm. height)

Il carrello regolabile in altezza permette la simulazione di giocatori in barriera che saltano al momento del calcio di punizione

This trolley allows free kick practicing simulating jumping defenders





Art. 001
+ Art. 003S

Art. 003S Carrello porta sagoma singola, antiribaltamento, in ferro zincato su ruote

Trolley for single Mannequin in galvanized steel on wheels

Il Carrello porta sagoma singola Art.003S impedisce alla sagoma di cadere a terra se colpita dalla palla

Trolley Art.003S allows mannequin to come back straight up when hit by the ball

pg.1



Art. 003S

Art. 001B Base porta sagoma zavorrabile in ferro zincato, per posizionamento su terreni sintetici

Peso: kg. 10 vuota, kg. 20 riempita con sabbia

Galvanized steel base to be filled with sand for mannequin positioning on artificial grass.

Weight: 10 kg. empty 20 kg. filled with sand



Art. 001B



Art. 001
+ Art. 001B



Art. 002R

Art. 001R

Art. 001R Rivestimento per Sagoma cm. 180 in nylon impermeabile antistrappo con cerniera

Nylon Cover for cm. 180 Mannequin with zip

Art. 002R Rivestimento per Sagoma cm. 160 in nylon impermeabile antistrappo con cerniera

Nylon Cover for cm. 160 Mannequin with zip



5 x Art. 001+ 5 x Art. 001R



5 x Art. 001 + 5 x Art. 001R + Art. 003RG

pg.1



LATO POSTERIORE
BACK SIDE



Art. 001TD Rivestimento tridimensionale per sagoma Art. 001
h. cm. 180 spessore cm. 20
in pvc monospalmato 360 gr/mq
imbottitura in eliocell d. 16 kg/mc
3D Cover 20 cm. thick
for mannequin Art.001
180 cm. height

QUESTI RIVESTIMENTI TRIDIMENSIONALI SIMULANO PERFETTAMENTE IL VOLUME DEL CORPO DEI GIOCATORI PERMETTENDO UNA SERIE DI ESERCIZI TECNICI E TATTICI CON E SENZA PALLA ANCORA PIU' REALISTICI E SICURI. L'IMBOTTITURA E' INOLTRE UTILE PER PROTEGGERE LA SAGOMA DAGLI URTI DELLA PALLA CALCIATA AD ALTA VELOCITA' DURANTE GLI ALLENAMENTI AI CALCI DI PUNIZIONE DI POTENZA



THESE 3D COVERS PERFECTLY RESEMBLE PLAYERS' BODIES ALLOWING EVEN MORE REALISTIC AND SAFE TECHNICAL AND TACTIC EXERCISES WITH AND WITHOUT BALL. THE SOFT SANDWICH PROTECTIONS ALSO AVOID POSSIBLE DAMAGES CAUSED BY HIGH SPEED POWER FREE KICK PRACTISING



pg.1

Art. 002TD Rivestimento tridimensionale per sagoma Art.002
h.cm.160
spessore cm. 20
in pvc monospalmato 360 gr/mq
imbottitura in eliocell d. 16 kg/mc
3D Cover 20 cm. thick
for mannequin Art.002
160 cm. height



Art. SAG205
Vista laterale
Side view

Art. SAG205
Sagoma Gonfiabile
h.cm.205
Inflatable dummy
205 cm. height

Ø base cm. 56
peso kg. 23
(pronta all'uso)
base Ø 56 cm.
weight 23 Kg.
(when ready for use)

Per un ordine minimo di 100 pezzi le sagome gonfiabili possono essere personalizzate con il Vs. logo e disegno (spese di impianto da quantificare)
Inflatable dummies can be customized with your image and logo: minimum order 100 pieces plus printing charge (only for the first time)

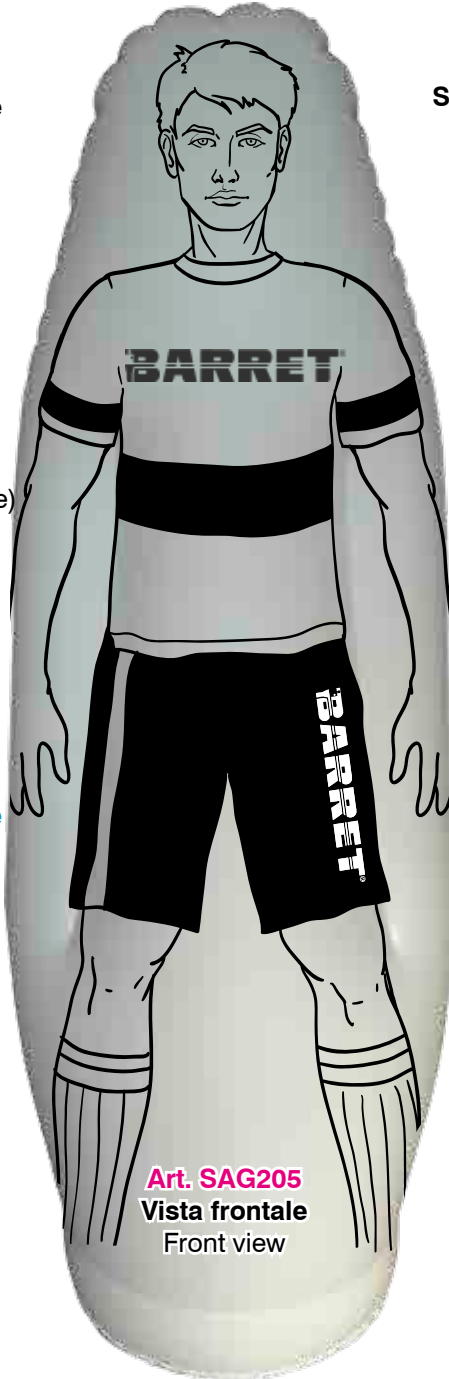

Art. SAG205
Vista frontale
Front view

Art. SAG175
Sagoma Gonfiabile h.cm.175
Inflatable dummy
175 cm. height



Ø base cm. 45
peso kg. 11
(pronta all'uso)
base Ø 45 cm.
weight 11 Kg.
(when ready for use)

Se colpite dalla palla o dal corpo dei giocatori durante gli esercizi, le sagome gonfiabili Barret tornano in piedi da sole

Barret Inflatable dummies always pop back up when hit by ball or players' body during exercises

Nate per l'allenamento dei portieri, le sagome gonfiabili Barret sono naturalmente utilizzabili anche per i calciatori, per l'effettuazione di una molteplicità di esercizi tecnici e tattici con e senza palla
Born for GK training, Barret inflatable dummies are very useful for lots of tactical and technical exercises involving players with and without ball

pg.1



Art. SAG205

Particolari della valvola superiore (rientrante) da utilizzare per il gonfiaggio della sagoma e della valvola inferiore (anch'essa rientrante) da utilizzare per il riempimento della base di appoggio a terra con acqua
The upper valve to inflate the body with air, the bottom valve to fill the base with water



Art. SAG175

ISTRUZIONI PER IL GONFIAGGIO E L'UTILIZZO DELLE SAGOME GONFIABILI

- 1) **Gonfiare la sagoma, ma non completamente. Il corpo deve rimanere sempre morbido, ed i fianchi non devono essere marcatamente sporgenti verso l'esterno rispetto alla base (fianchi e base zavorrata devono trovarsi quasi in linea retta gli uni rispetto all'altra)**
- 2) **Tenendo la sagoma distesa a terra, riempire il serbatoio con acqua: quando la sagoma comincia ad inclinarsi verso l'alto, chiudere il tappo del serbatoio e metterla in posizione verticale**
- 3) **Per la sagoma h. cm. 205 il livello dell'acqua deve arrivare appena sopra il tappo del serbatoio: inclinando la sagoma di 15° si deve vedere una bolla d'aria sulla valvola trasparente.
Per la sagoma h. cm. 175, invece, riempire completamente il serbatoio**
- 4) **Provare a spingere la sagoma lateralmente e osservare come torna in posizione eretta**
- 5) **Se si vuole che la sagoma si rialzi più velocemente, aggiungere dell'acqua (a discapito del peso) e gonfiare un po'**
- 6) **Se si gonfia ulteriormente la sagoma, distenderla a terra e fare uscire l'aria in eccesso dal serbatoio dell'acqua (il fondo deve essere piatto, non bombato)**
- 7) **Una volta trovato l'equilibrio desiderato, la sagoma può essere sgonfiata e rigonfiata (ad esempio, per trasportarla in luogo lontano) senza più svuotare il serbatoio dell'acqua**
- 8) **Se si utilizzano le sagome a basse temperature si consiglia di aggiungere alcol o antigelo nel serbatoio (non usare le sagome se l'acqua nel serbatoio è ghiacciata)**
- 9) **Non colpire le sagome con corpi appuntiti, non avvicinarle a fonti di calore, non trascinarle ma sollevarle sempre quando occorre spostarle, non sbatterle violentemente a terra**
- 10) **Per le riparazioni utilizzare l'apposito kit o Loctite 406 (altri prodotti non hanno efficacia sul materiale) Il prodotto è garantito solo per un utilizzo diligente che rispetti le istruzioni fornite**



USER'S INSTRUCTIONS

Inflatable dummies are entirely made with soft pvc: there are no rigid parts, so these products are absolutely safe. First, you have to inflate your dummy but not completely: you always have to keep the body soft, and hips have to be nearly in a straight line with the base (they must not be rounded). Then, by keeping it lying on the floor, you have to fill the tank with water: when the dummy rises up, close the valve and place it upright

For dummies 205 cm. high the water level must reach just over the valve, while for dummies 175 cm. high the tank can be filled completely

If you want your dummy to rise up more quickly when hit, add some water and inflate the body a little more. In this case, let the dummy lie on the floor for a while and let some air out from the tank (the base must be flat, not rounded)

Dummies can be used both on natural and artificial grass, on turf, gym floors etc.

Two side handles made of soft pvc are very useful to carry your dummy around: it is important to always lift your dummy when you need to move it (never pull it!) so the pvc base doesn't get scratched

When temperature is close to 0 degrees, it is necessary to add some alcohol inside the base (or some antifreeze liquid)

It is also available a kit for repair when inflatable dummies get damaged because used in wrong ways, in example when they are torn apart by players kicking with their studs against them



Art. 001SP
Sagoma Morbida telo PVC forato anti vento con 2 Paletti in PVC h. cm. 170
Soft pierced antiwind PVC Mannequin with 2 PVC Poles 170 cm. high

Art. 001SP3
Sagoma Morbida telo PVC forato anti vento con 2 Paletti in PVC h. cm. 130
Soft pierced antiwind PVC Mannequin with 2 PVC Poles 130 cm. high

Art. 001SPA
Sagoma Morbida telo PVC forato anti vento con 2 Paletti in alluminio h. cm. 170
Soft pierced antiwind PVC Mannequin with 2 aluminium Poles 170 cm. high

Art. 001SP6
Sagoma Morbida telo PVC forato anti vento con 2 Paletti in PVC h. cm. 160
Soft pierced antiwind PVC Mannequin with 2 PVC Poles 160 cm. high



pg.1

Art. SA001
Supporto per sagoma morbida in ferro verniciato utilizzabile su terreno sintetico
Base in painted iron for positioning any soft mannequin on artificial grass





pg.1

Art. 706244

Sagoma in plastica rinforzata anti urto su carrello a 4 ruote

altezza cm.190

Peso totale Kg.22

(kg.7 la sagoma - Kg.15 il carrello)

spessore sagoma cm.9

Mannequin in reinforced plastic
9 cm. thick with 4 wheel trolley
height 190 cm. weight 22 Kg.

LATO ANTERIORE
FRONT



pg.1

Art. 5026

Sagoma

Barret

in vetroresina

h. cm. 185

Fiberglass

Mannequin

185 cm. height

LATO POSTERIORE
BACK



Indistruttibili!
Unbreakable!

4 puntali in acciaio zincato alla base, per posizionamento su terreno naturale o su carrello portasagome

4 galvanized steel spikes at the base, for quick positioning on natural grass or on trolley



Art. 003RX
Barriera mobile
filtrante Reflex
completa
 Reflex training device on
 wheels - complete kit

pg.1

Art. 003RXS
Struttura superiore barriera
mobile filtrante Reflex,
applicabile al carrello porta
sagome Art. 003
 Reflex training device upper
 part, to be fixed upon
 trolley Art. 003



Art. 003RXS

Art. 003



Nuovo sistema di fissaggio
 New more resistant elastics
 and hooks



**INNOVATIVO ATTREZZO FONDAMENTALE PER
 L'ALLENAMENTO DEI RIFLESSI DEL PORTIERE.
 LA PALLA (INVISIBILE PER IL PORTIERE AL
 MOMENTO DEL CALCIO) FILTRA ATTRAVERSO
 LE STRISCE ED ARRIVA IN PORTA
 ALL'IMPROVISO ASSUMENDO TALVOLTA
 TRAIETTORIE IMPREVEDIBILI**

**ATTREZZO DA
 POSIZIONARE
 IN PROSSIMITA'
 DELL'AREA
 PICCOLA**
**To be placed not
 too far from goal-
 keeper's area**



**A new revolutionary
 device for goal-keeper's
 reflex training.
 The goal-keeper doesn't
 see the ball until it passes
 through the stripes.
 The direction of the ball
 is often unpredictable!**

**L'ATTREZZO PUO' INOLTRE ESSERE UTILIZZATO
 COME UNA COMUNE BARRIERA PER
 L'ALLENAMENTO DEI CALCI DI PUNIZIONE**

**It is also very useful for free kick practising for both
 kicker and goal-keeper!**



PALI SLALOM - Slalom Poles



Art. 007

pg.1

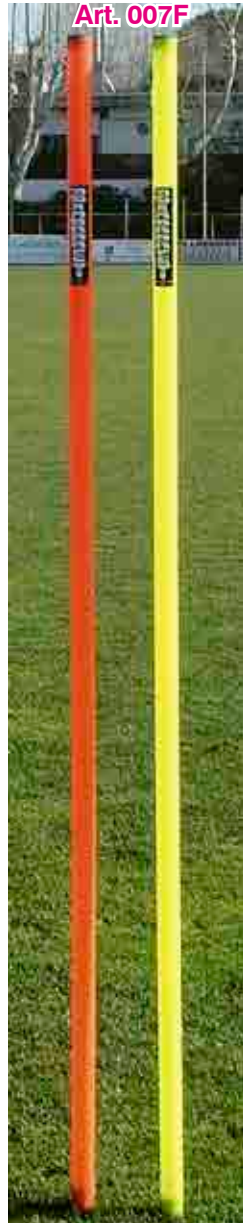

Art. 007F



Art. P007

pg.1



Art. 007 Paletto con puntale cm. 170 - PVC Ø mm. 32
Pole 170 cm. high in Pvc with galvanized metal spike



pg.1

Art. 007F
Paletto in polipropilene copolimero Ø 32 mm h.cm.163 con puntale zincato colore giallo o arancio fluorescente
Slalom Pole 163 cm. height in copolymer polypropylene 32mm. with galvanized metal spike (colors: fluorescent yellow and orange)



Art. P007
Paletto cm. 160 in polipropilene Ø mm. 30 con puntale e piattello di appoggio, colore giallo o arancio fluorescente
Pole 160 cm. h. in polypropylene, metal spike with ring (colors: fluorescent yellow and orange)

Art. A007



pg.1



Art. A007
Paletto cm. 170
in alluminio Ø mm. 32
con puntale zincato
 Pole 170 cm. high
 in aluminium with
 galvanized metal spike

Art. AS007



pg.1



Art. AS007
Paletto flessibile
cm. 170 in
alluminio Ø mm.
32 con puntale
zincato e molla
 Pole 170 cm. h.
 in aluminium with
 galvanized metal
 spike and spring

Art. S007



Art. S007
Paletto flessibile
cm. 170 in
Pvc Ø mm. 32
con puntale
zincato e
molla
 Pole 170 cm. h.
 in Pvc with
 galvanized metal
 spike and spring

Art. 007TL



cm. 170

cm. 90



pg.1



Art. 007TL
Paletto telescopico Ø 32 mm
h. cm. 170 in Pvc
con puntale zincato
(l'altezza si riduce sino a cm.90)
 Telescopic Pole 170 cm. h. in Pvc
 with galvanized metal spike
 Height can be reduced
 down to 90 cm.



Art. 010

Art. 010
Paletto pvc
Ø 32 mm
senza puntale
+ base
Pole without
metal spike
+ base



Art. 010C

Art. 010C
Paletto pvc
Ø 32 mm
senza puntale
+ base cilindrica
Pole without metal spike
+ cylindrical base

pg.2



Art. 010WR

Art. 010WR
Paletto pvc Ø 32
mm
senza puntale
+ base Art. HWRB
Pole without metal
spike
+ base Art. HWRB



Art. 018
Base in plastica
per paletto Ø 32 mm
con o senza puntale
Plastic base
for pole with
or without metal spike



Art. 902013
Base cilindrica in plastica
riempibile con sabbia o
acqua, solo per paletto
Ø 32 mm senza puntale
Cylindrical plastic base to
be filled with sand or water,
only for pole without
metal spike

Art. SP25
Asta in pvc Ø 25 mm
altezza cm 152
Pvc pole Ø 25 mm
height cm 152

Art. I-111
Clip ruotante
per montanti
Ø mm. 25 e 28
Rotating clip
for two pipes
Ø mm. 25 and 28

Art. E21
Traversa cm.120
in Pvc Ø mm. 25
Crossbar 120 cm.
in Pvc Ø 25 mm.

Art. TAH-X
Base riempibile con
sabbia per aste
Ø 25 mm. e cerchi piatti o
tubolari
Base to be filled with sand
for slalom poles Ø 25 mm.
and flat or tubular hoops

pg.2



Art. HWRB
Base in gomma zavorrata
per paletto Ø 32 mm con
o senza puntale
Weighted Rubber base
for pole with
or without metal spike



pg.1

Art. BFT
Borsa porta paletti
(capienza massima 30
pezzi)
Bag containing 30 poles

DELIMITATORI - Markers

**SPECIFICARE I COLORI RICHIESTI
AL MOMENTO DELL'ORDINE
PLEASE, SPECIFY COLORS
IN YOUR ORDER**

Art. 016

**Kit N° 48 Delimitatori h. cm.5
con rimessaggio (disponibile in 6 colori)**
Kit N° 48 Markers h. 5 cm. with holder
(available in 6 colors)

Art. 016.1

**Kit N° 48 Delimitatori h. cm.5
senza rimessaggio (disponibile in 6 colori)**
Kit N° 48 Markers h. 5 cm. without holder
(available in 6 colors)



Art. 016.B

**Kit N° 48 Delimitatori h. cm. 8
con rimessaggio
colori disponibili: giallo, rosso,
fucsia, arancio, blu, bianco**
Kit N° 48 Markers 8 cm. height with
holder (available colors: yellow, red,
fuchsia, orange, blue, white)

Art. 016F

**Kit N° 48 Delimitatori giallo o
arancio fluorescente
h. cm. 8 con rimessaggio**
Kit N° 48 Markers fluorescent
yellow or orange
h. 8 cm. with holder



pg.2

Art. 016.R

Art. 016.R5

**Art. 016.R Rimessaggio per delimitatori h. cm. 8
e delimitatori giganti**

Art. 016.R5 Rimessaggio per delimitatori h. cm. 5

Art. 016.R Iron Holder for 8 cm. and giant markers

Art. 016.R5 Iron Holder for 5 cm. height markers



Art. OSPT15

**Delimitatore piatto Ø 15 cm
colori giallo - rosso - arancio**
Flat round Marker Ø 15 cm.
colors:
red - yellow - orange

**Ideale per scuole,
palazzetti dello
sport
e superfici
sintetiche !
Great for indoor
and turf !**

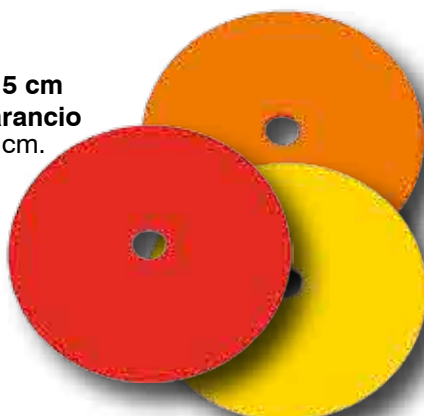

pg.3



Art. 015KT

Kit linea + angolo - 24 pz.
Kit Lines + angles - 24 pieces



Art. 016.T



pg.2

Art. 016.T

Kit N° 48 Delimitatori h. cm. 7 con rimessaggio e intagli sulla sommità colori disponibili: giallo e rosso

Kit N° 48 Markers with holder 7 cm. height carved on top (colors: red and yellow)



pg.3



Art. 016.K

Art. E21

Con l'uso di traverse consente la creazione di ostacoli di cm. 5 / 10 / 15 di altezza
Giant markers along with crossbars can create hurdles 5-10-15 cm. high

Art. 016.K

Delimitatore gigante con scanalature Ø cm. 30 h. cm.15 peso gr. 100 colori: giallo, arancio e bianco
Giant Marker 15 cm. height carved on top and sides (colors yellow, orange and white)



Art. E21 Traversa cm.120 in Pvc Ø mm. 25 - colori giallo, rosso, blu e verde
Crossbar 120 cm. in Pvc Ø 25 mm. (colors yellow, red, green and blue)

pg.3

BIRILLI - Cones

Art. 205000
Birillo calpestabile
in caucciù termoplastico
base Ø cm. 14 - h. cm. 15
colore giallo o rosso
Soft Cone 15 cm. height
14 cm. Ø base
colors red and yellow



Art. HA7
Birillo calpestabile
in caucciù termoplastico
base Ø cm. 18
h. cm. 18
colore giallo o rosso
Soft Cone
18 cm. height and
18 cm. Ø base
colors red and yellow

pg.3



Art. 023E
Birillo economico senza fori h. cm. 30
colori rosso e giallo
Light Cone 30 cm. height without holes
colors: red and yellow

pg.3



Art. 019

Art. 019
Kit 24 Maxidelimitatori cm. 28
colori: giallo, arancio, rosso,
royal e fucsia
Kit 24 Maximarkers, height 28 cm.
colors: yellow, orange, red, blue
and fuchsia



Art. B3S
Birillo senza fori cm. 30
con foro e scanalatura sulla sommità
colori: rosso, verde, blu e giallo
(disponibile fino ad esaurimento scorte)
Cone without holes height 30 cm.
with hole at the top
colors: red, green, blue and yellow
(until available in stock)

pg.3

Art. 023N
Birillo cm. 38
colore rosso,
giallo o blu
Cone height 38 cm.
colors:
red, yellow, blue

pg.3

Peso gr. 200
senza foro
sulla sommità
Weight 200 gr.
without hole
at top

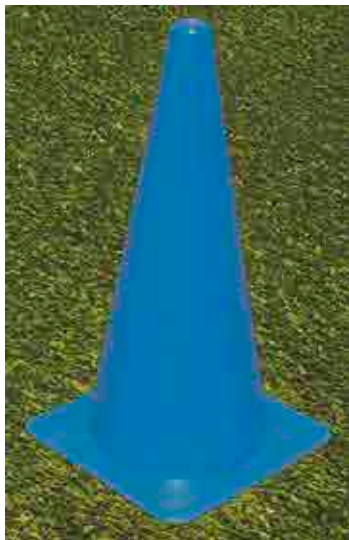

Art. 023
Birillo giallo cm. 40
con foro sulla sommità
Yellow Cone
with hole at the top

Art. 024
Birillo rosso cm. 40
con foro sulla sommità
Red Cone
with hole at the top

Art. 025
Birillo fucsia cm. 40
con foro sulla sommità
Fuchsia Cone
with hole at the top

pg.3

Peso gr. 450
Weight 450 grams



in 4 colori
in 4 colors



in 4 colori
in 4 colors

pg.3

Art. B312
Birillo a 8 fori cm. 30
Cone with
8 holes
height 30 cm.



Art. E21 Traversa cm.120 in Pvc Ø mm. 25 - colori giallo, rosso, blu e verde
Crossbar 120 cm. in Pvc Ø 25 mm. (colors yellow, red, green and blue)



Art. I-111
Clip ruotante
per montanti
Ø mm. 25 e 28
Rotating clip
for two pipes
Ø mm. 25 and 28

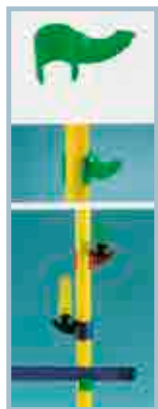

Art. I-110
Clip per montante
Ø mm. 25 e 28
e traversa
Clip for pipe
Ø mm. 25 and 28
and crossbar

pg.2



Art. I-112
Clip per montante
Ø mm. 25 e 28
e cerchio piatto
Clip for pipe
Ø mm. 25 and 28
and flat hoop

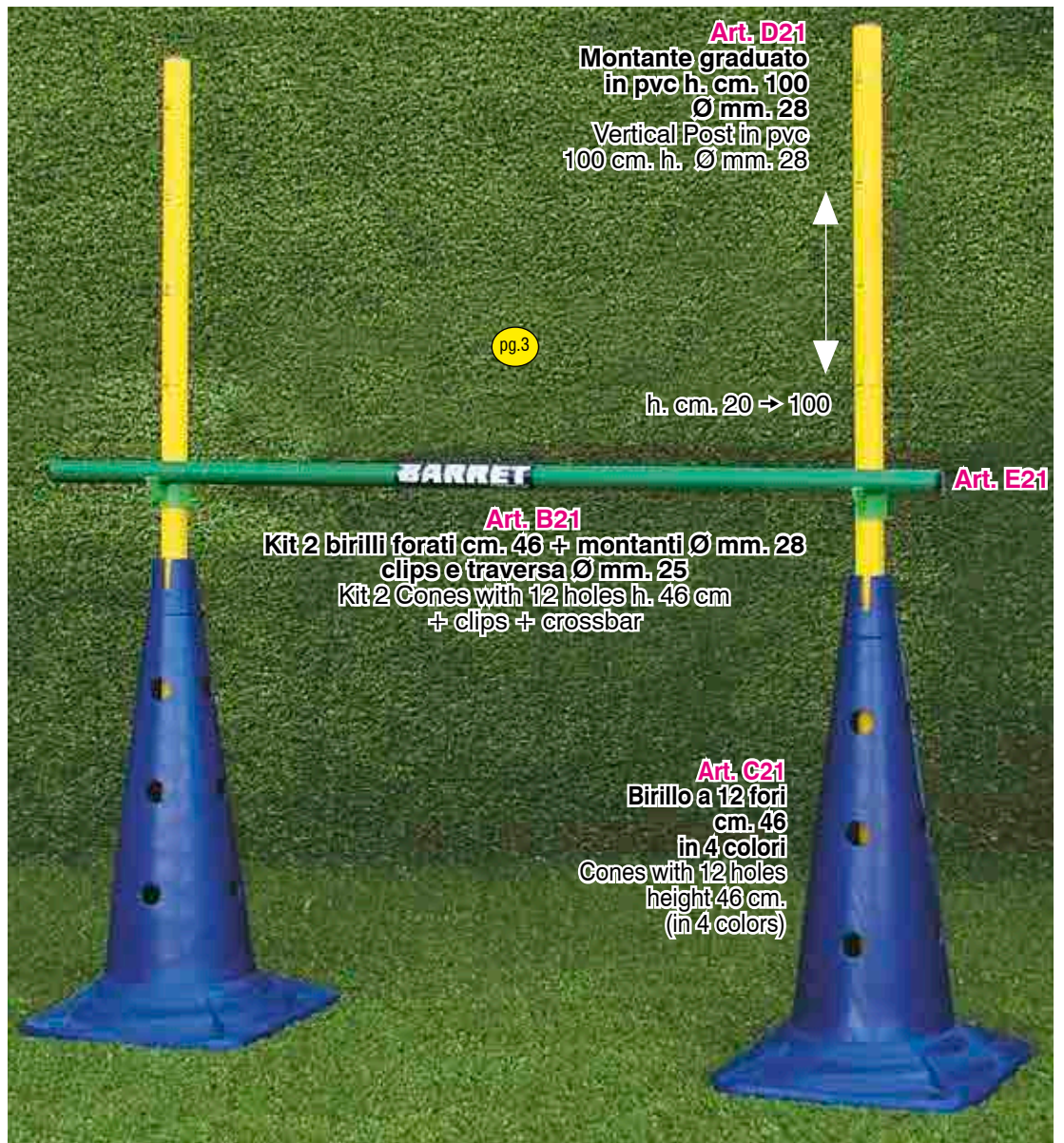

Art. D21
Montante graduato
in pvc h. cm. 100
Ø mm. 28
Vertical Post in pvc
100 cm. h. Ø mm. 28

pg.3

h. cm. 20 → 100

Art. B21
Kit 2 birilli forati cm. 46 + montanti Ø mm. 28
clips e traversa Ø mm. 25
Kit 2 Cones with 12 holes h. 46 cm
+ clips + crossbar

Art. E21

Art. C21
Birillo a 12 fori
cm. 46
In 4 colori
Cones with 12 holes
height 46 cm.
(in 4 colors)



Art. 525
Ostacolo regolabile con paletti,
ritti e traversa in Pvc Ø mm.32
 Hurdle with Poles,
 clips and crossbar in Pvc Ø 32 mm.

pg.2



Art. 5025
Ostacolo con Paletti
graduati, ritti e traversa
in Pvc Ø mm.32
 Hurdle with Graded Poles,
 clips and crossbar
 in Pvc Ø 32 mm

h. cm. 10 → 160



Art. 012
Traversa in Pvc cm.110 Ø mm. 32
 Crossbar 110 cm. in Pvc Ø mm. 32



Art. 525F
Ostacolo regolabile
costituito da 2 paletti h 170 cm. con
puntale, 1 traversa e 2 clip
in polipropilene copolimero
colore giallo o arancio fluo
 Hurdle with graded poles, clips and
 crossbar in copolymer polypropylene
 Ø 32 mm. (colors : fluorescent yellow
 and orange)

h. cm. 10 → 160



Art. 525F

pg.2



Art. 012F
Traversa cm. 110 in polipropilene
copolimero Ø mm.32
giallo o arancio fluo
 Crossbar 110 cm. in copolymer
 polypropylene Ø 32 mm.
 in fluorescent yellow and orange



Art. 029 Ostacolo graduato con basi,
altezza regolabile da 30 a 60 cm.
in Pvc Ø mm. 32
Graded Hurdle with bases, adjustable
height from 30 to 60 cm.
in Pvc Ø 32 mm



Art. 011
Clip per sostegno traversa
per tubo Ø mm. 32 o 28
Clip for crossbar for pipe
Ø mm. 32 o 28

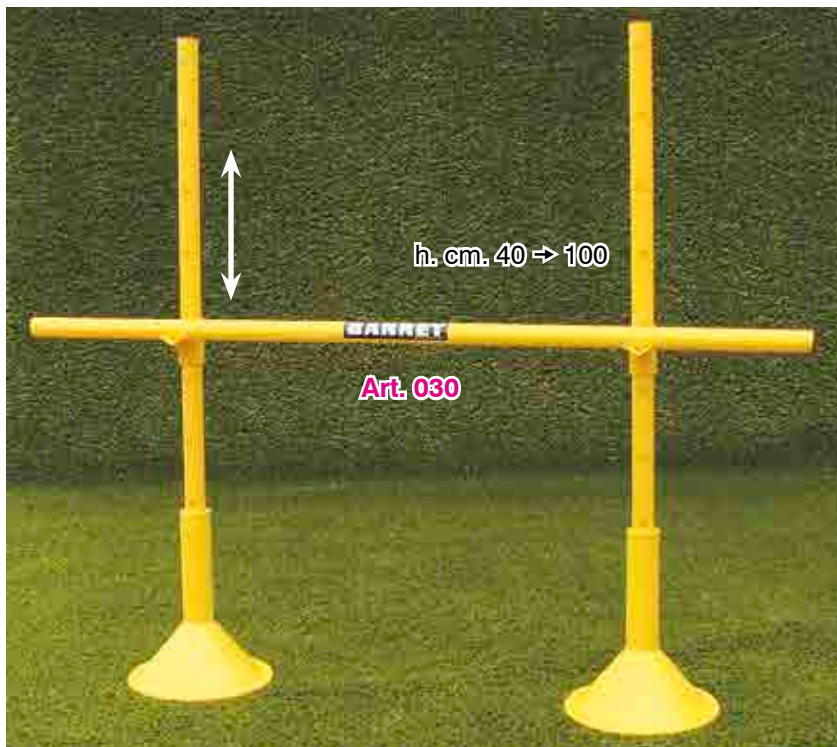

Art. 030

h. cm. 40 → 100



particolare

Art. 030
Ostacolo graduato con basi
altezza regolabile da 40 a 100 cm.
in Pvc Ø mm. 32
Graded Hurdle with bases,
adjustable height from 40 to 100 cm.
in Pvc Ø 32 mm

pg.2



Art. LL100
Ostacolo regolabile in PVC costituito
da 2 montanti Ø mm. 25
altezza cm. 100
con basi riempibili con sabbia
e traversa cm. 100
Adjustable height PVC Hurdle
with 100 cm. poles,
100 cm. crossbar Ø 25 mm.
bases to be filled with sand



particolare

OSTACOLI - Hurdles



Traversa cm. 45
45 cm. crossbar

Molto resistenti
Highly resistant

pg.4

Art. MH6 / MH9 / MH12
Mini-Over in Pvc
altezza fissa,
cm. 15 / 23 / 30
Ideali per bambini delle
scuole calcio

Mini-Over in PVC
fixed height,
15 / 23 / 30 cm.
Best for soccer
school kids



Larghezza
Traversa cm. 80
80 cm. crossbar

Flessibili ed indistruttibili
Flexible and unbreakable



Tornano in posizione
dopo ogni urto
senza danneggiarsi
These hurdles come
back in position after
any hit without being
damaged

pg.3

Art. 80.12 / 80.14 / 80.16 / 80.18
80.20 / 80.30 / 80.40 / 80.50 / 80.60
Ostacolo Over in Pvc
altezza fissa,
cm.12-14-16-18-20-30-40-50-60
Hurdle Over in PVC
fixed height,
12-14-16-18-20-30-40-50-60 cm.

pg.3 pg.4

Art.
P031-A / P031 / P032
P033 / P034 / P035
Ostacoli Over
in Pvc Ø mm. 32
altezza fissa,
disponibile
da 12 a 60 cm.
Hurdles Over in Pvc,
fixed height
available
from 12 to 60 cm.



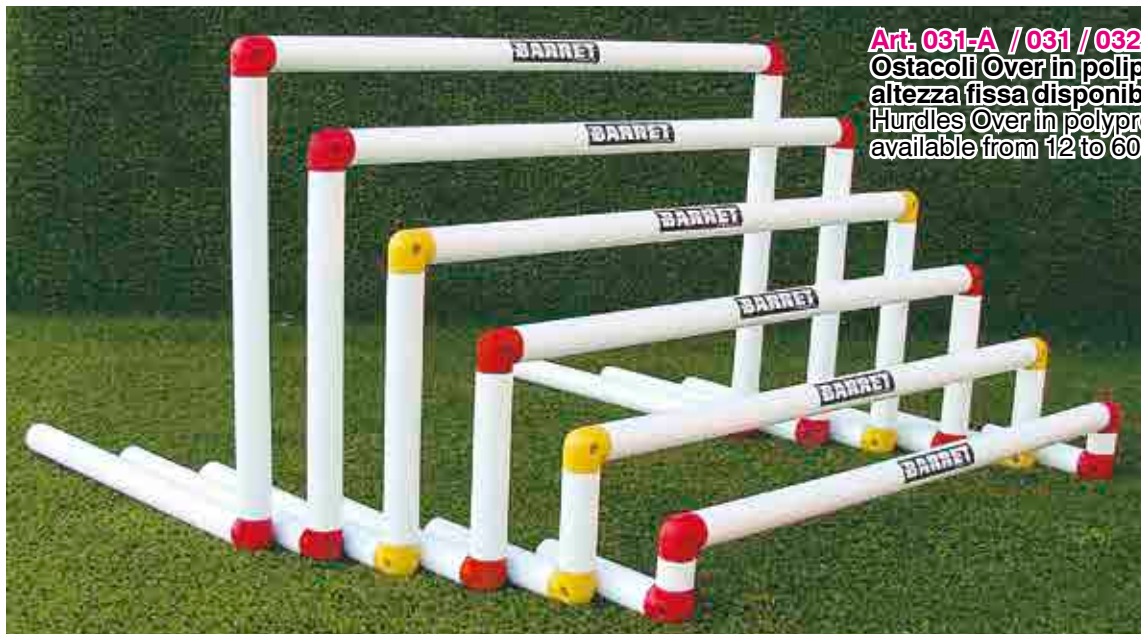

Art. 031-A / 031 / 032 / 033 / 034 / 035
Ostacoli Over in polipropilene Ø mm. 40
altezza fissa disponibile da 12 a 60 cm.
Hurdles Over in polypropylene, fixed height
available from 12 to 60 cm.

Polipropilene
copolimero
Ø 40 mm.
altamente
resistente e
flessibile fino a
-5 gradi !
Polypropylene
copolymer
40 mm. highly
resistant and
elastic till minus
5 degrees !

pg.4



Art. 235.1 / 235.2 / 235.3 / 235.4 / 235.5 / 235.6
Ostacoli Over
in ferro verniciato altezza fissa
disponibile da 12 a 60 cm.
Hurdles Over in painted iron,
fixed height available
from 12 to 60 cm.



pg.4

Art. A031-A / A031 / A031-B / A032 / A033 / A034 / A035
Ostacoli Over in alluminio Ø mm. 32 altezza fissa disponibile da 12 a 60 cm.
Hurdles Over in aluminium, fixed height available from 12 to 60 cm.

pg.4

Art. 031-AF
031F / 031-BF / 032F
033F / 034F / 035F

Ostacolo over
altezza fissa
cm. 12-20-30-40-50-60
in polipropilene
copolimero
alta resistenza
Ø mm. 32
colori: giallo e arancio
fluorescente
Over Hurdle 12 - 20 - 30
40 - 50 - 60 cm. height
polypropylene
copolymer
pipe Ø mm. 32
(colors: fluorescent
yellow and orange)



Polipropilene
copolimero
FLUO
altamente
resistente e
flessibile fino a
-5 gradi !
Polypropylene
copolymer
fluorescent
highly
resistant and
elastic till minus
5 degrees !

Art. C031 / C032 / C033 / C034

Ostacolo Over
con cerniere (richiudibile) in
polipropilene
copolimero Ø mm. 32
colore giallo o arancio
fluorescente
massima altezza
cm. 20 - 30 - 40 - 50
Hinged Hurdle Over
(foldable) in polypropylene
copolymer pipe Ø mm. 32
(fluorescent yellow and orange)
20 - 30 - 40 - 50 cm.
maximum height



pg.4

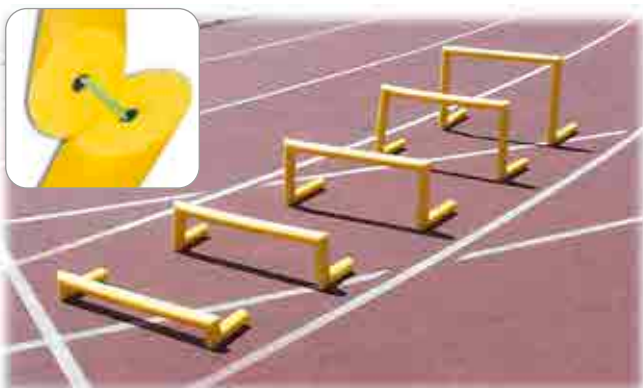

pg.5

Art. P15421
Serie 5 ostacoli Over supersoft in polietilene
espanso colore giallo, leggerissimi
ideali per uso indoor
altezza cm. 10-20-30-40-50 (il set comprende
un ostacolo per ciascuna altezza)
Set of 5 Hurdles over supersoft yellow color
very light, for indoor use only
fixed height cm. 10-20-30-40-50



pg.5

Art. 006
Ostacolo con cerniere (richiudibile)
altezza regolabile da 10 a 60 cm.
in PVC Ø mm. 32
Hinged Hurdle (foldable)
adjustable height
from 10 to 60 cm. in PVC

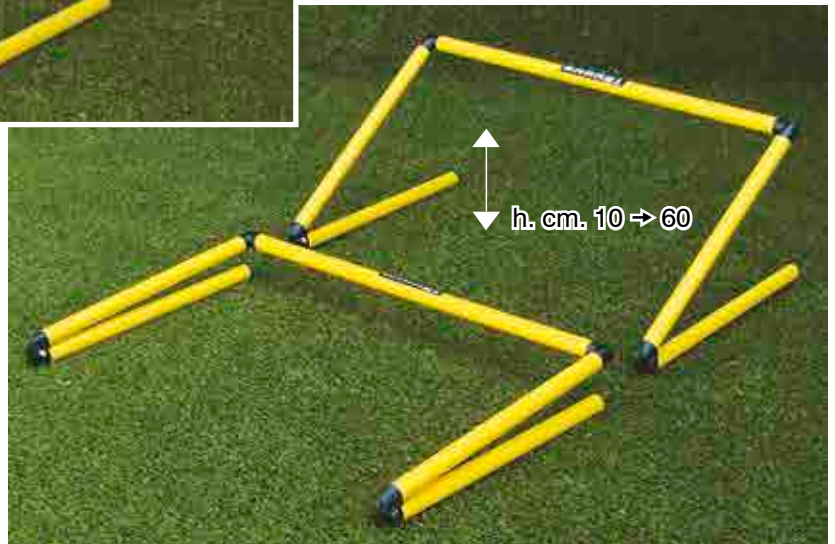

pg.5

Art. 006F
Ostacolo con cerniere (richiudibile)
altezza regolabile da 10 a 60 cm.
in Polipropilene copolimero Ø mm. 32
colore giallo o arancio fluorescente
Hinged Hurdle 10 - 60 cm. adjustable height
(foldable) in polypropylene copolymer
pipe Ø mm. 32
(colors : fluorescent yellow and orange)



pg.5

Art. A004 **Ostacolo con cerniere (richiudibile)**
altezza regolabile da 10 a 60 cm.
in alluminio Ø mm. 32
Hinged Hurdle (foldable) adjustable height
from 10 to 60 cm. in aluminium





**SEMPRE IN PIEDI
DOPO OGNI URTO!
THEY ALWAYS COME
BACK UP AFTER
ANY HIT!**



pg.5

Art. 5020 / 5021 / 5022 / 5023
Ostacoli Basculanti in Pvc Ø mm. 28
altezza fissa cm. 30 / 40 / 50 / 60
Self-Straightening Hurdles in PVC fixed height,
available in 30 / 40 / 50 / 60 cm.

pg.5

Art. A5020 / A5021 / A5022 / A5023
Ostacoli Basculanti in alluminio Ø mm. 28
altezza fissa cm. 30 / 40 / 50 / 60
Self-Straightening Hurdles in aluminium
fixed height, available in 30 / 40 / 50 / 60 cm.



**SEMPRE IN PIEDI
DOPO OGNI URTO!
THEY ALWAYS COME
BACK UP AFTER
ANY HIT!**



Art. P0055
Ostacolo Telescopico graduato, altezza regolabile da 40 a 60 cm. in Pvc
Telescopic Hurdle - graded - height adjustable from 40 to 60 cm. in Pvc

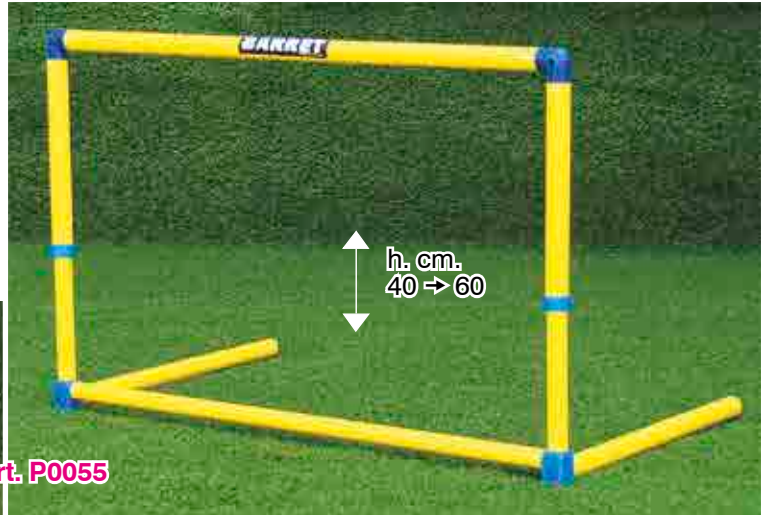

Completamente smontabili, minimo ingombro!
Dismountable legs, easy to transport

pg.5

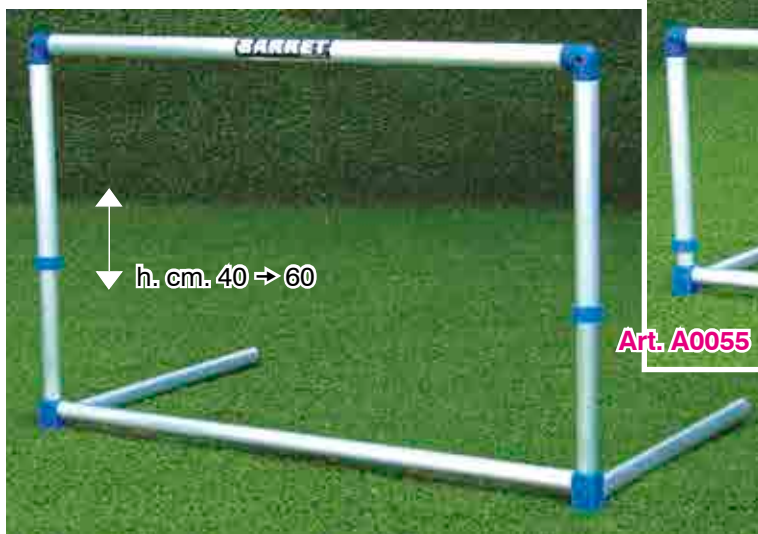

Art. A0055

Art. A0055
Ostacolo Telescopico graduato, altezza regolabile da 40 a 60 cm. in alluminio
Telescopic Hurdle - graded - height adjustable from 40 to 60 cm. in aluminium

Montanti graduati cm. per cm. Graded in cm.

Completamente smontabili, minimo ingombro!
Dismountable legs, easy to transport



Art. P005
Ostacolo Telescopico graduato,
altezza regolabile da 60 a 100 cm. in Pvc
Telescopic Hurdle - graded - height adjustable
from 60 to 100 cm. in Pvc

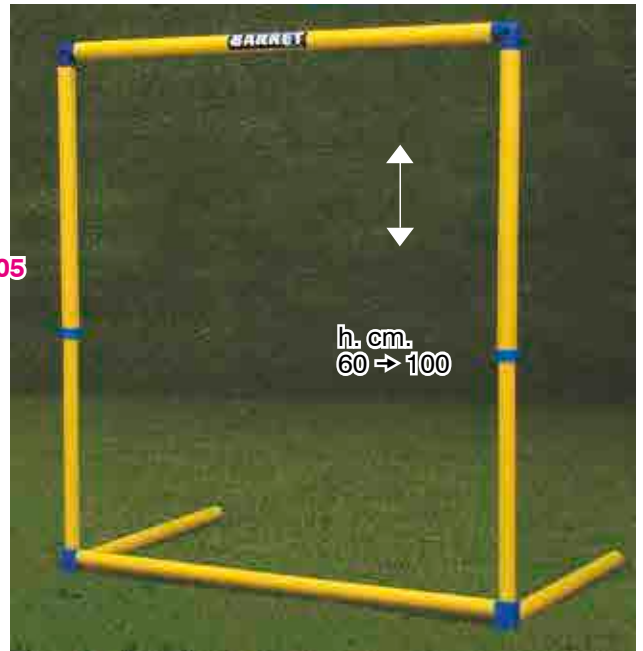
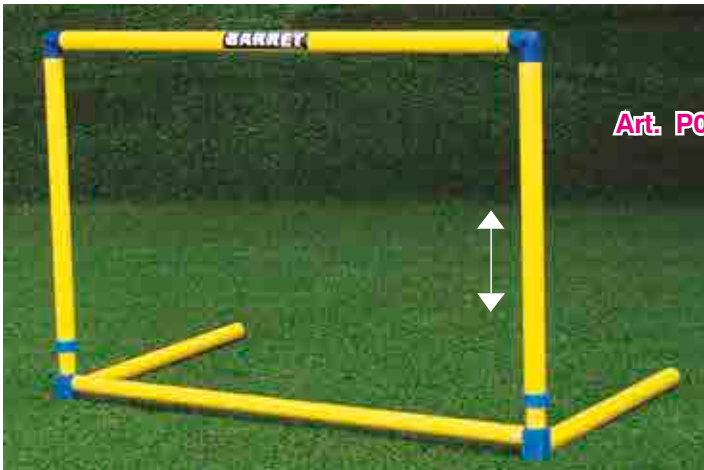

Completamente smontabili, minimo ingombro!
Dismountable legs, easy to transport



Art. A005 pg.5
Ostacolo Telescopico graduato,
altezza regolabile da 60 a 100 cm. in alluminio
Telescopic Hurdle - graded
height adjustable from 60 to 100 cm. in aluminium

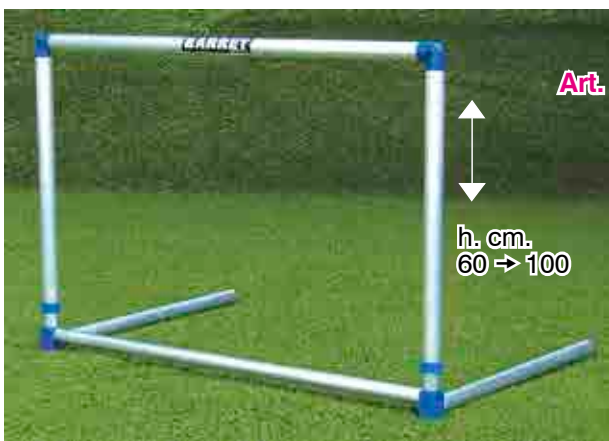

Completamente smontabili, minimo ingombro!
Dismountable legs, easy to transport



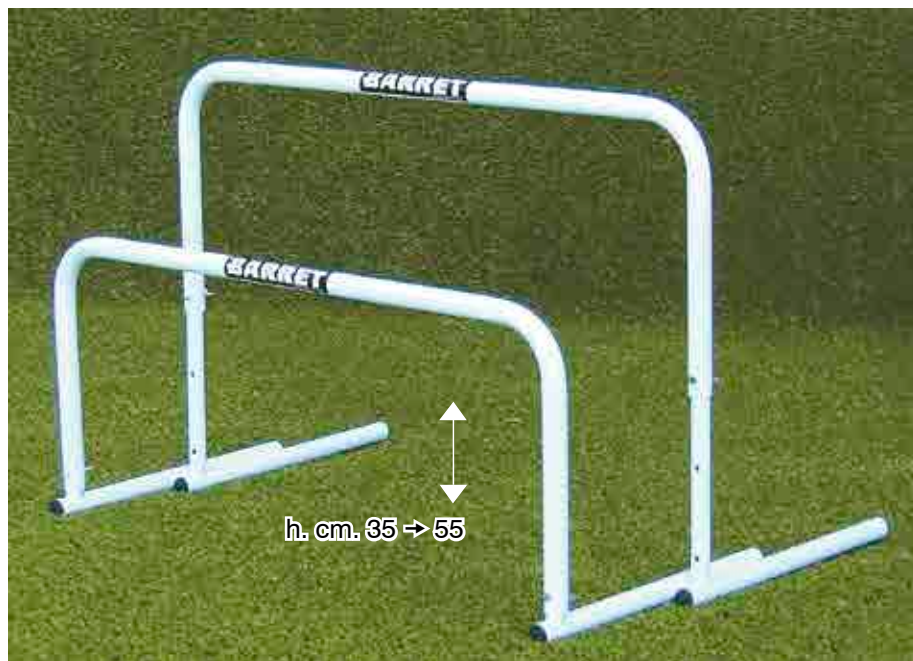

Art. 236
Ostacolo Telescopico regolabile da 35 a 55 cm. in ferro verniciato
Telescopic Hurdle adjustable height from 35 to 55 cm. in painted iron

pg.5

Art. 237
Ostacolo Telescopico regolabile da 60 a 90 cm. in ferro verniciato
Telescopic Hurdle adjustable height from 60 to 90 cm. in painted iron

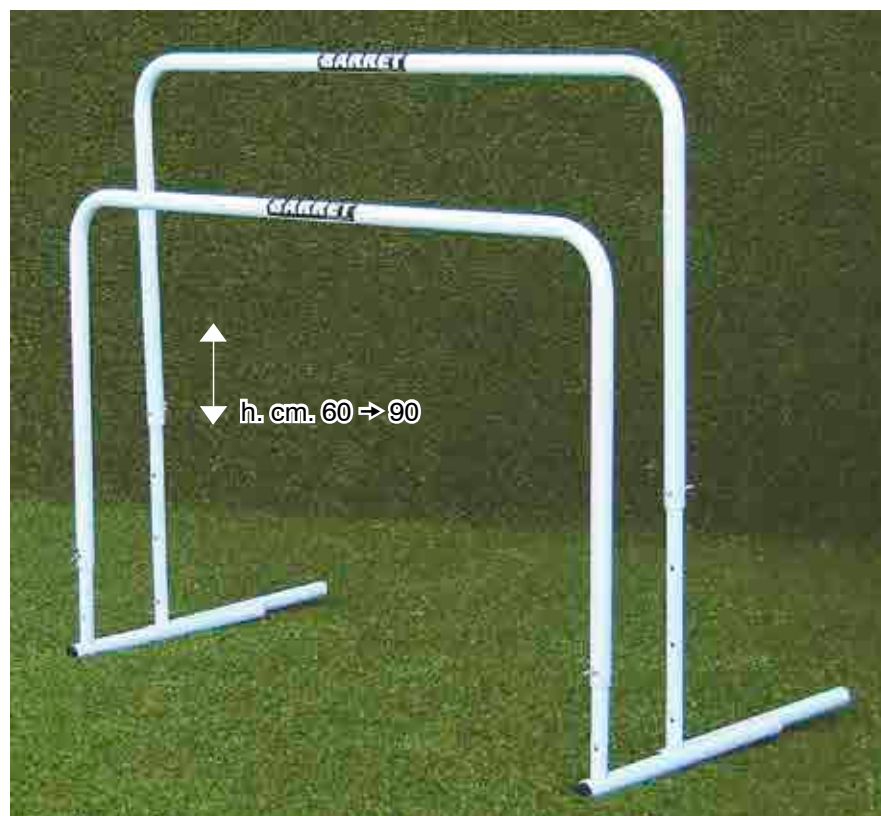

Art. 036
Mini Ostacolo regolabile da 10 a 50 cm. in plastica
Mini-Hurdle adjustable height from 10 to 50 cm. in plastic

IDEALI PER USO INDOOR E PER PALESTRE

For indoor use

KIT CALCIO TENNIS - Soccer Tennis Kits

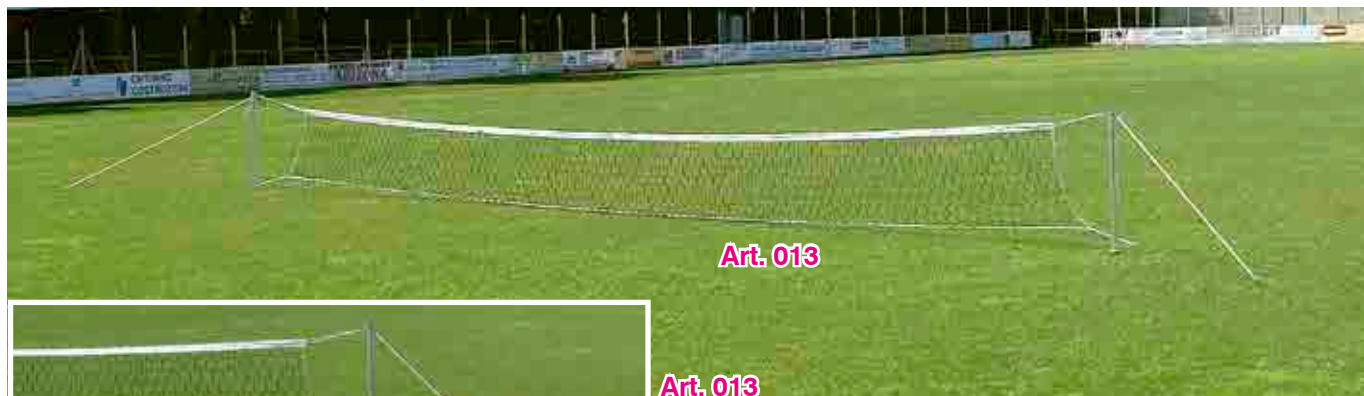

Art. 013



Art. 013

Kit Calcio Tennis pali in alluminio sezione 60 mm. completo di rete mt. 9, tiranti, picchetti e delimitazione utilizzabile solo su terreni naturali
Soccer Tennis Kit aluminium poles with 9 meter net, tightening ropes, pegs and tape for bounds - for natural grass

pg.6



Art. 014

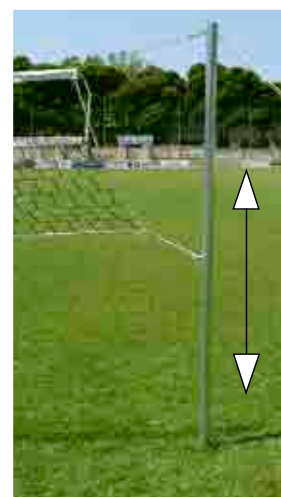

Art. 014
Kit Calcio Tennis pali in alluminio sezione 60 mm. completo di rete mt. 9 (regolabile a 3 altezze) tiranti, picchetti e delimitazione utilizzabile solo su terreni naturali
Soccer Tennis Kit aluminium poles 60 mm. 9 meter net adjustable at 3 different heights, tightening ropes, pegs and tape for bounds - for natural grass

Rete regolabile a 3 altezze
Adjustable height net



Art. 014



Art. NS200
Rotolo nastro stradale mt. 200 - bianco/rosso
Red/White Tape length 200 meters

pg.28



Art. 013.N
Kit Calcio Tennis pali in Pvc
completo di rete mt. 3,30
tiranti e picchetti
per terreni naturali
Soccer Tennis Kit Pvc poles
with net 3,30 meters
tightening ropes and pegs
For natural grass

pg.5



Art. 013.G Kit calcio tennis pali in pvc
con rete mt.10 - altezza cm.130
con tiranti, picchetti e sacca
per terreni naturali
Soccer Tennis Kit with Pvc poles
10 meter long 130 cm. height net with
ropes steel hooks and bag
for natural grass



pg.5

Art. 013.P
Kit calcio tennis
con rete mt. 3
utilizzabile anche
su terreni sintetici
o indoor
con sacca
Soccer Tennis Kit
3 meter net - with bag
also for artificial
grass or indoor



Art. 013.SP

**Kit calcio tennis con rete cm. 450x170
utilizzabile anche
su terreni sintetici o indoor
con sacca**

Soccer Tennis Kit 4,5x1,7 meter net
with bag also for artificial grass or indoor



Art. 013.60

**Kit calcio tennis
con rete cm. 600x150
utilizzabile anche
su terreni sintetici o indoor**

Soccer Tennis Kit 6,0x1,5 meter net
also for artificial grass or indoor

● pg.5



Art. 013.S

**Kit Calcio Tennis TATTICO
pali in polipropilene
completo di rete in Pvc mt. 2,30 regolabile in
altezza, tiranti e basi in ferro verniciato
utilizzabile anche su terreni sintetici o indoor**

Soccer Tennis Kit polypropylene poles
with adjustable height pvc net 2,30 meter long,
tightening ropes and painted steel bases
also for artificial grass or indoor

**Nasconde per qualche istante la visione
del pallone, determinando risposte a livello
neuromuscolare e migliorando cinestesia e
sensibilità nel tocco di palla**

This Soccer Tennis Kit hides the ball from
player's visibility stimulating neuro muscular
reflexes and improving ball control



Art. 013.SB

**Borsa porta Kit calcio tennis
Art. 013.S**

Bag to carry soccer tennis
kit Art. 013.S

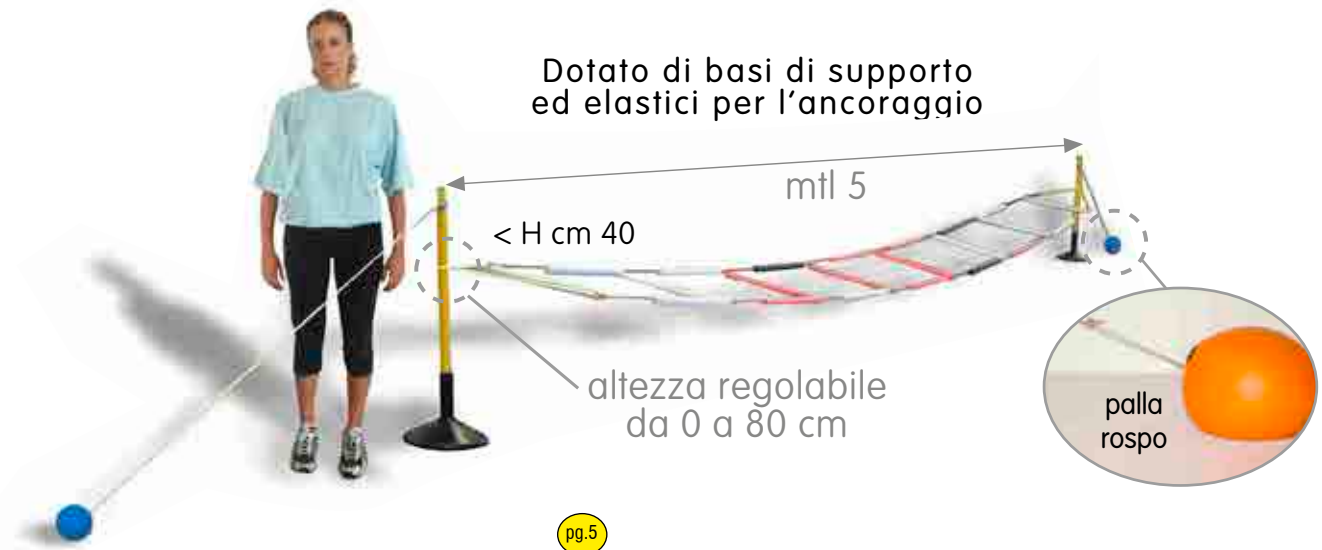

Art. T10076
Coordinatore di Frequenza / Calcio tennis
lunghezza m. 5 utilizzabile anche su superfici sintetiche
attrezzo sicuro, privo di picchetti in metallo
Soccer Tennis Kit / Speed Ladder
length 5 meters - also for indoor or artificial grass
safe without any metal spikes

Ideale per bambini
scuole calcio
best for soccer school kids



pg.6

Art. T10075
Attrezzo per slalom e tiri di precisione
lunghezza mt.7,32 - altezza mt. 1,80
utilizzabile anche su erba sintetica e indoor
attrezzo sicuro, privo di picchetti in metallo
Slalom and shooting training device
length 7,32 mt. - height 1,80 mt
also for artificial grass and indoor
safe (without metal pegs)



ARCHI DI PRECISIONE - Precision passing arcs



Art. AP35

**Archi di precisione
in pvc tubo pieno
larghezza cm.35**

Shooting/Passing Arcs
in pvc - full flexible pipe
35 cm. wide

pg.5

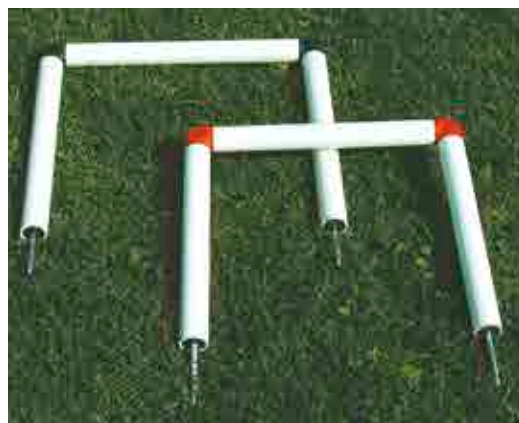

Art. 020 / 021 / 022

**Archi di precisione in polipropilene
Ø 40 mm. cm. 45x45 / 40x40 / 35x35**

Shooting/Passing Arcs
in polypropylene Ø 40 mm.
dim. 45x45 / 40x40 / 35x35 cm.



Art. A020 / A021 / A022
**Archi di precisione
in alluminio Ø 32 mm.
cm. 45x45 / 40x40 / 35x35**
Shooting/Passing Arcs
in aluminium Ø 32 mm.
dim. 45x45 / 40x40 / 35x35 cm.



FORCHE - Heading Trellises



Art. F203

pg.6

Art. F203
Forca doppia
in ferro verniciato
(palloni esclusi)
telescopica, smontabile
bussola inclusa
altezza da terra cm. 300
Double Heading Trellis
in painted iron
(balls not included)
telescopic, dismantable,
underground base
included,
height 300 cm. off ground



pg.6

Art. 037F
Forca singola
in acciaio zincato,
con zavorra,
per erba sintetica
o indoor
(pallone escluso)
altezza da terra cm.300
Single Heading Trellis
in galvanized iron weighted
for artificial grass or indoor
(ball not included)
height 300 cm. off ground



Art. ULTVE5
Pallone per forca
Trial n. 5
in gomma
doppio strato
gr. 420
Ø cm. 21,5
Trial rubber Ball
for Heading trellis
size 5
double stratum

pg.6

Art. ULTVE4
Pallone per forca Trial n. 4
in gomma doppio strato gr. 250 Ø cm. 20
Trial rubber Ball for Heading trellis size 4 double stratum



Art. 038
Forca doppia
in alluminio
tubo sezione 60 mm.
(palloni esclusi)
altezza da terra
cm.300
Double Heading Trellis
in aluminium
pipe section 60 mm.
(balls not included)
300 cm. height off
ground

Art. B038
Bussola per forca
(optional)
Underground Base
(optional)



pg.6

Art. 039.4 - 039.5
Pallone per
forca in pelle sintetica
disponibile mis. 4 e 5
Ball for Heading Trellis,
in synthetic leather
available size 4 and 5



pg.9

Con questo attrezzo
è possibile verificare
giornalmente i
miglioramenti
nell'elevazione
degli atleti
This instrument
tests players' daily
jump improvements

Art. HJT Head Jump Tester Strumento polivalente di misurazione e allenamento, permette la valutazione delle qualità muscolari degli arti inferiori, dell'elevazione dei giocatori, del loro modo di colpire la palla di testa e dell'ampiezza del tuffo del portiere
Instrument that allows the training and measurement of jump ability of players and goal-keepers

MURI - TELAI CON RETE - Rebounders - Iron frames with nets



Vista frontale
Front view

pg.6



Vista laterale
side view

Art. 5011

Muro per allenamento portieri in vetroresina,
montato su 4 ruote di cui una frenante
Fiberglass Goal-Keeper Rebounder on 4 wheels

Dimensioni :
altezza cm. 200
larghezza cm. 130
Peso Kg.100

Dimensions:
height 200 cm.
width 130 cm.
weight : 100 Kg.

Calciando o lanciando la palla
verso il muro essa assumerà
direzioni di rimbalzo
imprevedibili, favorendo
l'allenamento dei riflessi
del portiere

Kicking or throwing the ball
towards the wall, the ball will rebound in
different directions,
testing and training GK's reflexes



Vista posteriore
Back view

Consente l'allenamento con o senza il
preparatore atletico
goalkeeper can exercise by himself
as well



Con superficie superiore a semisfere e
superficie inferiore liscia
Upper side with emispheres
and smooth lower side





Kg. 50



Art. 5010 Muro per allenamento giocatori a 3 facce in vetroresina montato su 3 ruote
3 side Fiberglass Players' Rebounder on 3 wheels
Dimensions: 1,3 x 1,1 m. every side weight 50 Kg.

pg.6



Attraverso l'uso della parete reclinabile è possibile determinare traiettorie di risposta della palla verso l'alto al fine di sollecitare il tiro al volo, il colpo di testa ed il controllo di palla
Thanks to the adjustable inclination you can get an upward ball rebound and train acrobatic shooting, headers and ball control

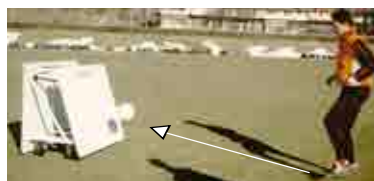

pg.6



Dimensions: 1,3 x 1,1 m. every side Weight 50 Kg.



Art. 5050 Muro allenamento giocatori a 2 facce (1 inclinabile) interamente in vetroresina montato su 4 ruote
2 side Fiberglass Player's rebounder on 4 wheels one side can be inclined



pg.6

Art. TM001 Muro triangolare in legno multistrato marino, trattato con vernice impermeabilizzante dim. lato cm.150x50
Attraverso l'uso in posizione verticale è possibile determinare traiettorie di risposta della palla verso l'alto al fine di sollecitare il tiro a volo, il colpo di testa e lo stop
Triangular wooden rebounder - side size 150x50 cm. you can place it in vertical position, in order to receive an upward ball rebound and train acrobatic shooting, header and ball control.
Made of marine wood treated with special paint against humidity

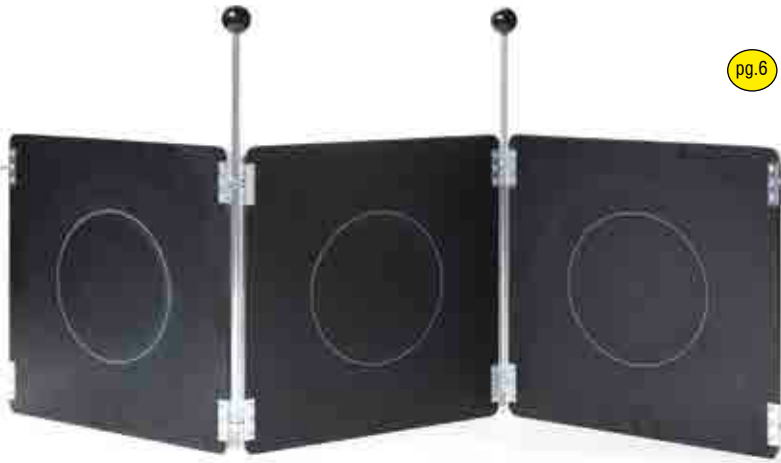

**Art. PAL PAL ORIGINAL - Kit 3 pannelli orientabili
in legno finlandese trattato a 5 strati rivestiti in gomma,
completo di 4 aste metalliche di fissaggio, 6 pomelli di sicurezza
e 1 martello per il fissaggio**

Pal Original - Kit 3 rebounding sides in Finnish multi stratum wood covered with rubber, with 4 metal pegs, 6 safety protections and 1 hammer

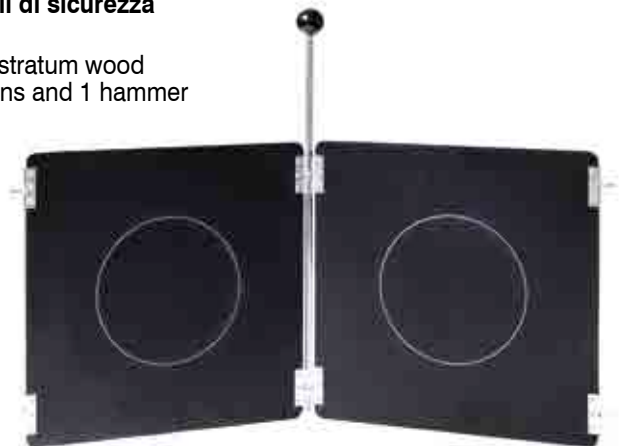

**Ideale per l'effettuazione
di esercizi individuali e di
gruppo volti al miglioramento
della coordinazione motoria,
del controllo di palla,
del passaggio, del tiro
e del gioco aereo**
Very useful for individual and
group exercises to improve
coordination, ball control,
passing and shooting



Art. 5030.T
Telaio con rete in alluminio
dim. cm. 90x70
ad inclinazione regolabile
con maniglie impugnabili
dall'allenatore.
Consente
la simulazione di colpi di testa
e tiri acrobatici per un
allenamento alternativo
del portiere

Aluminium frame with net
size 90x70 cm.
adjustable inclination
with handles for trainer
to simulate headers and acrobatic
shooting trajectories
for new GK exercises





kg.55

Art. 5041



Art. 5041

Telaio con rete cm. 320 x 235 in ferro zincato ad inclinazione regolabile, per allenamento portieri e giocatori
 Iron frame with net, in galvanized iron dimensions 320 x 235 cm. adjustable inclination for goal-keepers and players



kg.25

Art. 5040 Telaio con rete cm. 140 x 140 in ferro zincato ad inclinazione regolabile, per allenamento portieri e giocatori
 Iron frame with net, in galvanized iron dimensions 140x140 cm. adjustable inclination for goal-keepers and players

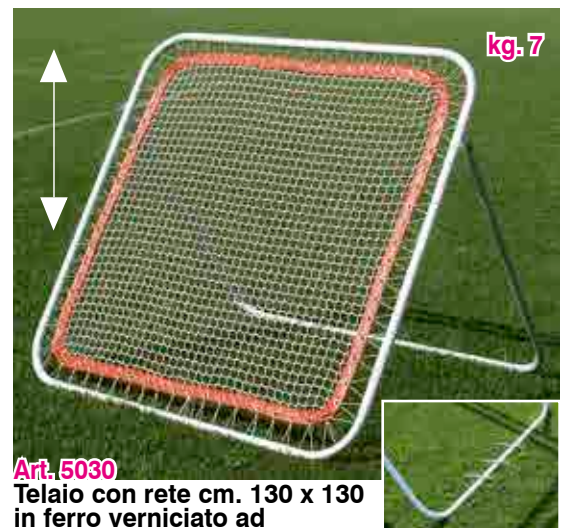

kg.7

pg.6

Art. 5030

Telaio con rete cm. 130 x 130 in ferro verniciato ad inclinazione regolabile
 Painted iron frame with net, dimensions 130x130 cm. adjustable inclination

con picchetti di ancoraggio with anchoring hooks

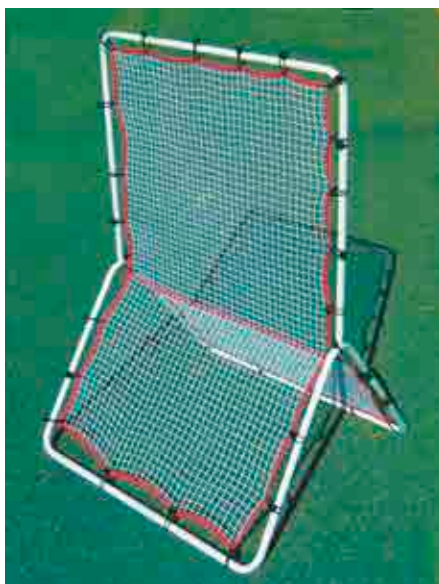

Art. 503.BF

Telaio con rete in ferro verniciato, bifacciale e a doppia inclinazione, altezza cm.150 - larghezza cm.100 con picchetti per fissaggio a terra, per allenamento portieri e giocatori
 Iron frame with net, in painted iron 2 sides - double fixed inclination height 150 cm. - width 100 cm. with anchoring hooks for goal-keepers and players



Art. DT01
Deviatore di traiettoria
 Pali in alluminio, con cerniere e piedini di stabilità.
 Coadiuvano l'allenamento quotidiano del portiere ed il suo eventuale recupero post traumatico.
BREVETTATO
 DEVIATOR - poles in aluminium, with hinges and stability pegs - very useful to improve GK reactivity and to accelerate injury recovery
PATENTED

Richiedeteci il DVD dimostrativo di questo incredibile attrezzo

DVD available !!

Brevettato Patented

● pg.6

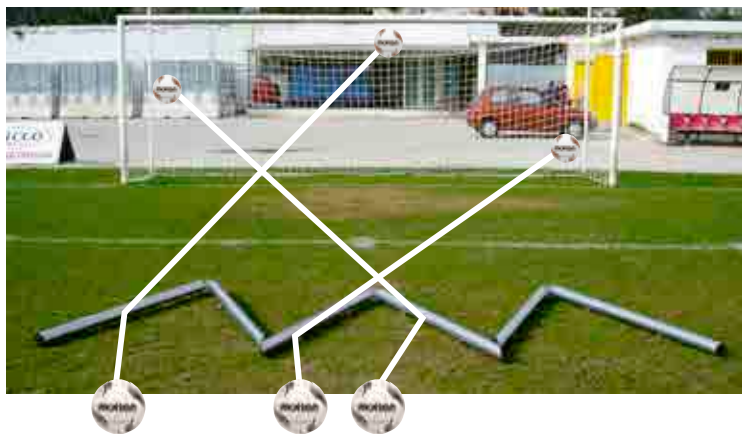

Si consiglia di inumidire l'erba di fronte all'attrezzo per incrementare la velocità della palla calciata rasoterra prima dell'impatto con il Deviatore
 We recommend to wet the grass in front of the training device in order to let the ball hit the deviator at higher speed



Art. BP63
BALL PLAINING - Telo in Pvc per l'allenamento dei riflessi del portiere - metri 6 x 3 colore standard bianco
 (serigrafabile su richiesta)
 White Ball Plaining for G.K. training in Pvc size 6x3 meters (color and logo on request)

● pg.6



New!

Per allenamento tuffi portieri ed acrobazie giocatori
 For gk dive and players' acrobatic shooting training

● pg.46

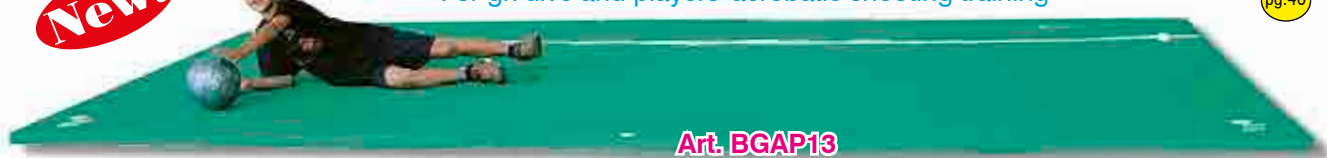

Art. BGAP13
Tappeto Ammortizzante pieghevole dimensioni cm. 200x450 superficie in vinile monospalmato - fondo antiscivolo, imbottitura densità 40 kg/mc
 Foldable soft Mat for goal-keeper and players' safe dives - size 200x450 cm.



PROPRIOCETTIVITA' - Equilibrium training

Art. IS441

Tavoletta propriocettiva in legno su emisfera, con rivestimento antiscivolo Ø cm. 40
 Wooden Equilibrium Board with emisphere bottom side, Ø 40 cm. base with antiskid surface



Art. 168PC

pg.7

Art. 168PC
Tavoletta propriocettiva in plastica su emisfera, Ø cm. 41 regolabile in altezza
 Plastic Equilibrium Board with emisphere bottom side Ø 41 cm. adjustable height



Art. 167-L

Art. 167-L Tavoletta propriocettiva in legno su emisfera, base di appoggio cm. 30x30
 Wooden Equilibrium Board with emisphere bottom side, base 30x30 cm.



Art. 167-T

pg.7



Art. 169-R

Art. 169-R Tavoletta propriocettiva in legno su semiluna, base di appoggio cm.60x40 con rivestimento in gomma antiscivolo
 Wooden Equilibrium Board, with half moon bottom side, base dimensions cm.60x40 with anti-skid surface



Art. 167-T

pg.7

Art. 167-T Tavoletta propriocettiva in legno su emisfera, Ø base di appoggio cm. 60 con rivestimento in gomma antiscivolo
 Wooden Equilibrium Board with emisphere bottom side, base Ø 60 cm. with anti-skid surface



Art. 169-V Tavoletta propriocettiva in vetroresina su semiluna, base di appoggio cm.60x40
 Fiberglass Equilibrium Board, with half moon bottom side, base dimensions cm. 60x40



pg.7

Art. 167-V Tavoletta propriocettiva in vetroresina su emisfera, Ø base di appoggio cm. 60
 Fiberglass Equilibrium Board with emisphere bottom side, base Ø 60 cm.



Art. MH9T / MH16T Semisfera gonfiabile Trial per riabilitazione e stimolazione propriocettiva diam. cm. 9 o cm. 16
Half-spheres inflatable for rehabilitation Ø 9 or 16 cm.



pg.7



Art. FTN-DB Cuscino gonfiabile puntinato Ø cm 32,5
Cylinder inflatable for rehabilitation Ø cm 32,5



Art. FY8911 Cuscino gonfiabile puntinato Ø cm 39
Cylinder inflatable for rehabilitation Ø cm 39



Art. C1 Pedana Cilindrica gonfiabile Trial per riabilitazione e stimolazione propriocettiva dim. cm. 32,5x6
Cylinder inflatable for rehabilitation dim. 32,5x6 cm.

pg.7



Art. C2 Pedana Cilindrica gonfiabile Trial per riabilitazione e stimolazione propriocettiva, dim. cm. 40x9
Cylinder inflatable for rehabilitation dim. 40x9 cm.



Resistenti ai tacchetti Stud proof



Art. C3 PEDANA SuperSkimmy Trial per riabilitazione e stimolazione propriocettiva gonfiabile cm.40x9 con spalla rinforzata
Cylinder inflatable 40x9 cm. reinforced on sides



**Art. T1 Medusa Trial - struttura instabile base Ø cm. 45
altezza cm. 23 per riabilitazione e stimolazione
equilibrio, in gomma doppio strato
massima instabilità**

Medusa for rehabilitation
and equilibrium training
double stratum rubber
Ø 45 cm. base
height 23 cm.

**Resistente
ai tacchetti
Stud proof**



pg.7



**Resistenti ai
tacchetti
Stud proof**

**Art. T3
Pedana instabile
con base inferiore
antiscivolo**

Ø cm. 55
altezza cm. 15
studiata per
i campi sintetici,
specifica per
i più giovani
Unstable Medusa
with antiskid bottom
55 cm. Ø base
height 15 cm.
ideal for artificial
grass and young
players



pg.7



**Art. T1.1
Medusa Trial Ø cm.45
altezza cm. 23
con piatto rigido
alla base
per conferire
maggiore stabilità**
Medusa 45 cm. Ø base
height 23 cm.
with rigid bottom for
better stability

New!



**Resistente
ai tacchetti
Stud proof**



**Nuova maniglia
New handle**



pg.7



**Art. T2 Tartaruga Trial - struttura instabile base Ø cm. 65 altezza cm. 24
per riabilitazione e stimolazione equilibrio, in gomma doppio strato**
Medusa double stratum rubber Ø 65 cm. base height 24 cm. - for rehabilitation and equilibrium training



Art. TCRAZY / TCR.T2
CRAZY HORSE
 per allenamento
 di equilibrio
 "estremo"
 da effettuarsi
 in coppia
 For Extreme
 balance training

pg.7



Art. 468481 Balance Mat - cm. 40x50x5,5
 Alta densità - High density

pg.7



Art. TBEFS
BLOCCO PER STRETCHING tendineo e muscolare
 (flessori caviglia e coscia, dorso etc.)
 con appoggio soffice e sagomato a 2 inclinazioni
 ideale per il defaticamento e per il recupero
STRETCHING BLOCK for ankle, leg, back muscles and
 tendons - with soft double inclination
 very good for after-training exercises

Art. TA-I

Coppia tappeti propriocettivi a isole a 2 densità diverse:

**1 tappeto a densità 120 gr. con isole densità 30 gr. - 1 tappeto densità 30 gr. con isole densità 120 gr.
 dimensioni tappeti m.2x1 modulabili con velcro (a formare 1 materasso m.4x1 o m.2x2)**

Pair of Mats 2x1 meter each (when together 4x1 or 2x2 meter) :

1 mat 120 gr. density with 30 gr. density round areas ; 1 mat 30 gr. density with 120 gr. density round areas

pg.7

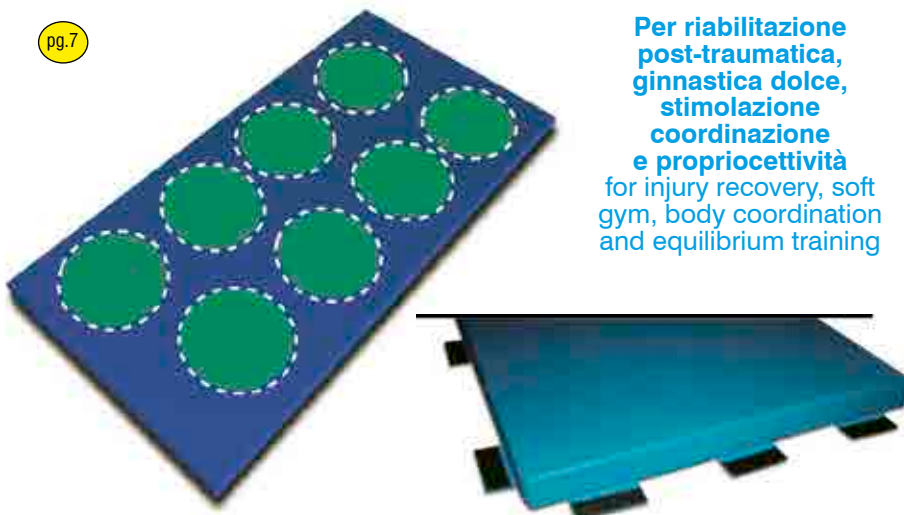

**Per riabilitazione
 post-traumatica,
 ginnastica dolce,
 stimolazione
 coordinazione
 e propriocettività**
 for injury recovery, soft
 gym, body coordination
 and equilibrium training





Art. V9178
Plinto per pliometria regolabile in altezza da cm. 30 a cm. 45 in tubolare di acciaio zincato piano di appoggio in legno multistrato dim. cm.150x30
Pliometric bench adjustable heights (from 30 to 45 cm.) in galvanized steel - wooden board dim. 150x30 cm.

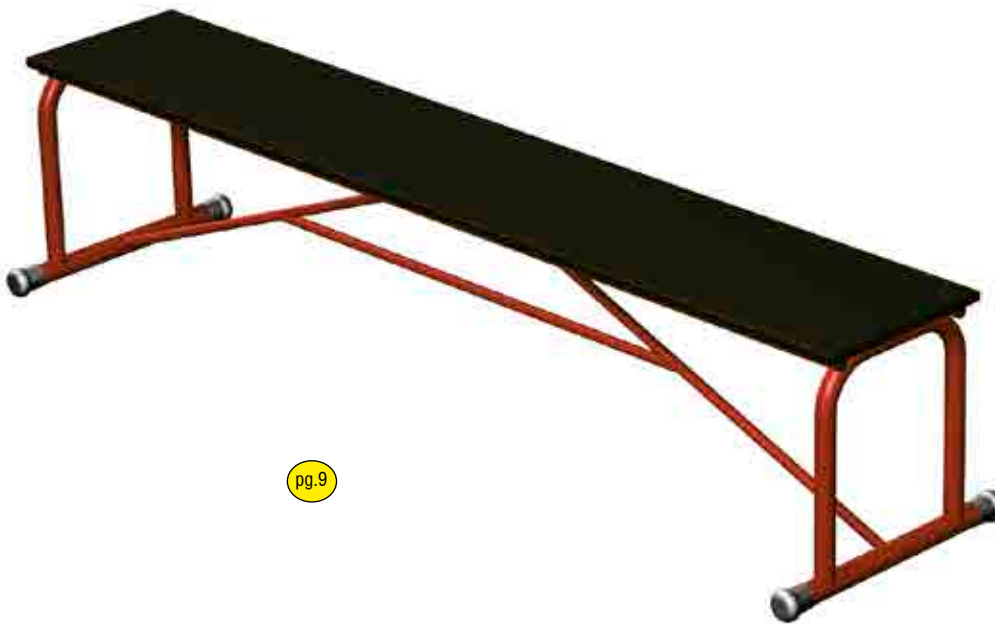

pg.9

Art. 1/2/3 PP40 - 1/2/3 PP50
Panca per pliometria in acciaio verniciato, lunghezze disponibili: cm. 100 / cm. 200 / cm. 300 larghezza cm. 35 altezze disponibili: cm. 40 o cm. 50 piano di appoggio in legno rivestito in gomma antiscivolo
Pliometric bench in painted steel, available length 100 / 200 300 cm. width 35 cm. available height 40 or 50 cm. board made of wood with antiskid rubber cover



Art. PAV2 Set 3 plinti soft a basi rettangolari, sovrapponibili - 3 altezze ottenibili: cm. 30, 60, 90 in gommapiuma rivestita in pvc ignifugo Cl. 1
Set of 3 rectangular base soft steps placing them one upon the other you can set them at 3 different heights: 30, 60, 90 cm.

TRAMPOLINI CERCHI CORDE BASTONI - Trampolines Hoops Cords Sticks



Art. 166
Trampolino elastico
Ø cm. 97
Trampoline
Ø 97 cm.

Art. V1709
Trampolino elastico
ad altezza fissa
dim. cm.125x125
Trampoline 125x125 cm.
reinforced



pg.6

pg.7



Art. S01154
Trampolino elastico
ad inclinazione
regolabile
completo di protezioni
dim. cm. 125x125
Trampoline
size 125 x 125 cm.
adjustable inclination
with soft perimetral
protection

Art. TRO-12
Trampolino da esterno Ø cm. 305
portata massima Kg. 100
Outdoor Bouncer cm. 305 diameter

Art. TRO-22
Rete di protezione perimetrale
per trampolino TRO-12 (optional)
Optional perimetral protection net for Art.TRO-12

New!



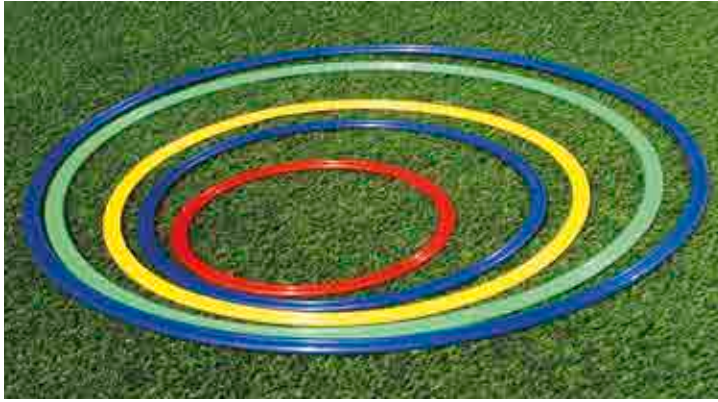

Art. CNP30 / CNP40 / CNP50 / P00181 / P00191 / P00201
Cerchi in nylon piatti, Ø cm. 30 / 40 / 50 / 60 / 70 / 80
Flat Nylon Hoops Ø 30 / 40 / 50 / 60 / 70 / 80 cm.



Art. P00182 / P00192 / P00202 / P00212
Cerchi in Pvc tubolari,
Ø cm. 60 / 70 / 80 / 90
Tubular Pvc hoops
Ø 60 / 70 / 80 / 90 cm.



Art. S00414
Mensola porta bastoni a parete
in acciaio verniciato
Stick wall Holder in painted steel

Art. S00402/S00404/S00406/E21
Bastoni in legno e Pvc colorato
cm. 80 - 100 - 120
Wooden and Pvc Sticks



Art. OCC11
Connettore per
cerchi piatti
Flat Hoop Connector



Art. S00472
Mensola porta cerchi a parete
in acciaio verniciato
Hoop wall Holder in painted steel

pg.7

pg.8



Art. 043
Corda per salto con manici in legno
ed ingrossamento centrale
Skipping Rope with hardwood handles
thicker in the middle section



Art. 043P
Corda per salto con
manici in legno
Skipping Rope with
hardwood handles



Art. CS1
Corda per salto in canapa
con ingrossamento
centrale (senza manopole)
Jumping cord thicker in the
middle without handles



Art. 043L Corda per
salto in pelle
Leather Skipping Rope
with hardwood handles

SCALE - ALLENAMENTO SOTTO CARICO - Speed Ladders - Training with weights



Art. SL4
**Scala a 10 pioli rotondi
lunghezza m. 4
per esercizi di
coordinazione motoria
(compresa sacca
per il trasporto)**
Speed ladder,
with 10 tubular rungs
length 4 meters,
for quick step and
coordination exercises,
bag included

pg.8

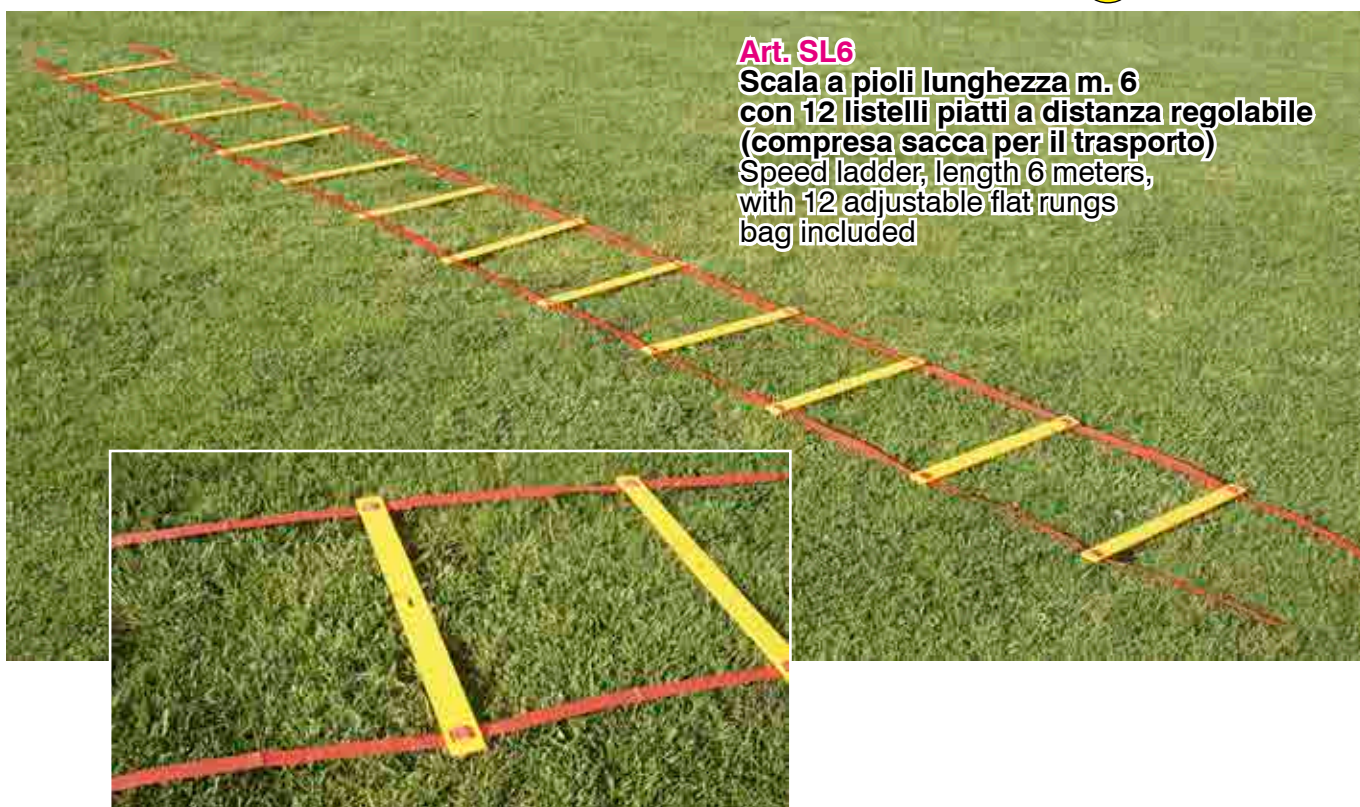

Art. SL6
**Scala a pioli lunghezza m. 6
con 12 listelli piatti a distanza regolabile
(compresa sacca per il trasporto)**
Speed ladder, length 6 meters,
with 12 adjustable flat rungs
bag included



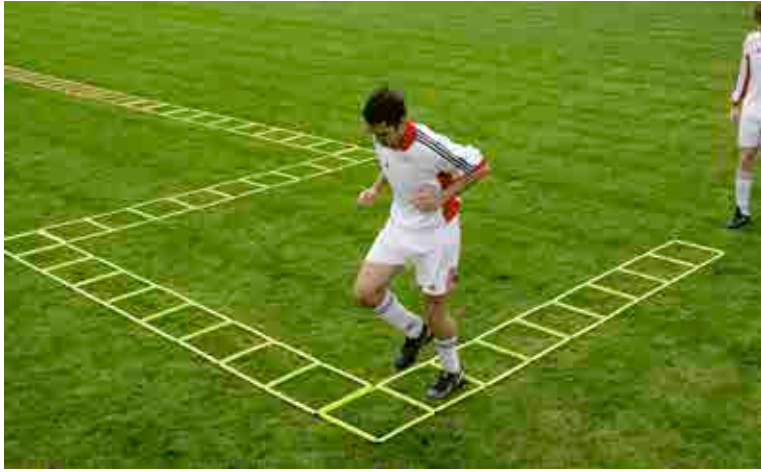

Art. 708241

**Scala a pioli in plastica pieghevole lunghezza m.4
con 10 pioli - spessore cm.1,5
dimensione quadrati cm.40x40 - con rimessaggio**

Rigid Speed ladder length 4 meters - in plastic pipes 1,5 cm. thick
foldable with holder

pg.8



Art. K4111

Kit scala Art.708241 + 20 Minibirilli Art.701411

Kit Art. 708241 + 20 x Art.701411



Art. 701411

**Mini-birillo
concavo altezza cm. 9
per sollevamento
scala Art.708241**

Cone 9 cm.
height carved on top
also for Art.708241
underneath support





Art. STAR

Starkick - completo di cintura e corda elastica, per allenamento ai palleggi ed al tocco di palla (pallone escluso)

STARKICK with belt and elastic rope for ball kick and control training (ball not included)

pg.8



Art. OTK

Training Kicker con corda elastica per allenamento ai palleggi ed al tocco di palla (pallone escluso)

Training Kicker - with elastic rope for kick and ball control training (ball not included)



Art. TIM.SP

Supporto per Tackle improver
Holder for Tackle improver

Art. TIM

Tackle improver per allenamento al contrasto
For tackle training

Uno strumento innovativo per migliorare la tecnica di esecuzione e la potenza del contrasto.

Il Tacke Improver indirizza il piede d'appoggio verso la posizione più idonea per esprimere la maggiore potenza d'impatto.

Potenzia inoltre tutte le catene muscolari che intervengono nel contrasto, ma senza causare traumi, grazie ad una speciale molla collegata al pistone che sorregge il pallone.

Very useful training device for strengthening all muscles involved in tackling.

Absolutely safe, thanks to a spring and piston system that avoids injuries.



pg.9



Art. CVCO

Cavigliera Coordinativa con contrappeso, migliora l'equilibrio e l'indipendenza psicomotoria delle gambe ed in particolare ammorbidisce la gamba dominante migliorandone la sensibilità del piede.

Rotating ankle, with weight, to improve equilibrium and leg independence : in particular it softens the dominant leg improving sensibility of the non dominant foot



pg.8

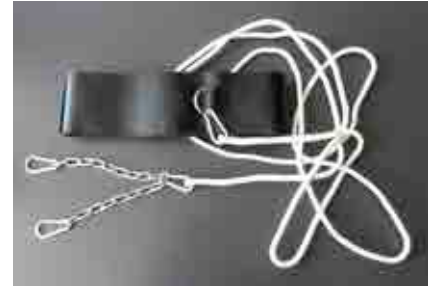

Art. SLD



Art. ASN
Cintura in pelle sintetica con velcro completa di corda e moschettoni di ricambio per slitta Art. SLD
Synthetic leather belt, rope and chains spare for Art. SLD

New!

Art. SLD Slitta per il miglioramento della capacità di accelerazione tramite il traino a carico variabile completa di cintura in pelle sintetica con velcro, corda e moschettoni (dischi in ghisa non inclusi)
Sledge (weights not included) improving acceleration with synthetic leather belt, rope and chains

Art. CBV
Cintura in pelle sintetica con velcro di ricambio per Art. SLD
Synthetic leather belt w/velcrum spare for Art. SLD



pg.8



Art. PCH
Paracadute - per potenziamento della corsa - esercizio individuale
Parachute - to improve the power of your run individual training



Art. V5083
Pedana di salto in tubo in acciaio dim. cm. 100x100 con elastico rigido a tensionamento uniforme e dinamometro, cintura e moschettoni (dischi in ghisa non inclusi)
Jump Platform in painted steel dim. 100x100 cm. with elastic rope and dynamometer, belt and hooks (weights not included)



Art. 991301
Cintura zavorrata fino a 5 Kg. (pesi estraibili)
Belt weighted up to 5 Kg.

Art. 045
Giubbino caricabile con pesi fino a 10 Kg. (pesi inclusi)
Weighted Jacket (up to 10 Kg.) weights included





New!



Art. 991310/991311/991312
Shoulder Bag con 3 maniglie Kg. 10/15/20
Shoulder Bag with 3 handles 10/15/20 Kg.

pg.8



New!

Art.991318/.../991324
BORSA ZAVORRATA cm.75 con 4 maniglie - nucleo in sabbia e rivestimento in gommapiuma
pesi disponibili Kg.6-8-10-15-20-25-30
HEAVY BAG with 4 handles - interior in sand, covering in foam rubber
weights available 6-8-10-15-20-25-30 Kg.

New!



pg.10

MTLTX

Lacci di Trazione

attrezzo polifunzionale per il potenziamento della catena estensoria e flessoria degli arti superiori e inferiori
Traction Laces
multi-purpose belt for the enhancement of the extension and flexion muscular chains of the upper and lower limbs



*Utilizzati da Antonio Giacobbe e Marco Tamburini
rispettivamente capo allenatore e preparatore fisico della Nazionale Egiziana maschile di Volley*

BOA - BANDE ELASTICHE - BOA - Elastic Bands



pg.10



New!

Art. 016824

ELASTICO BOA in gomma para mm.7x18 rivestito con guaina di sicurezza blu lunghezza mt. 3 - con 1 moschettone a ciascuna estremità
 Rubber BOA 7x18 mm. with safety blue sheath - 3 meter lenght

Art. 016825

CINTURA Junior da agganciare a elastico BOA - diametro max cm.105
 Junior Belt for Boa traction - max diameter 105 cm.

Art. 016826

CINTURA Senior da agganciare a elastico BOA - diametro max cm.140
 Senior Belt for Boa traction - max diameter 140 cm.



Art. IFBG

Fitness band gialla yellow
 cm. 175x15



Art. IFBR

Fitness band rossa red
 cm. 175x15



Art. IFBV

Fitness band verde green
 cm. 175x15



Art. IFBB

Fitness band blu blue
 cm. 175x15

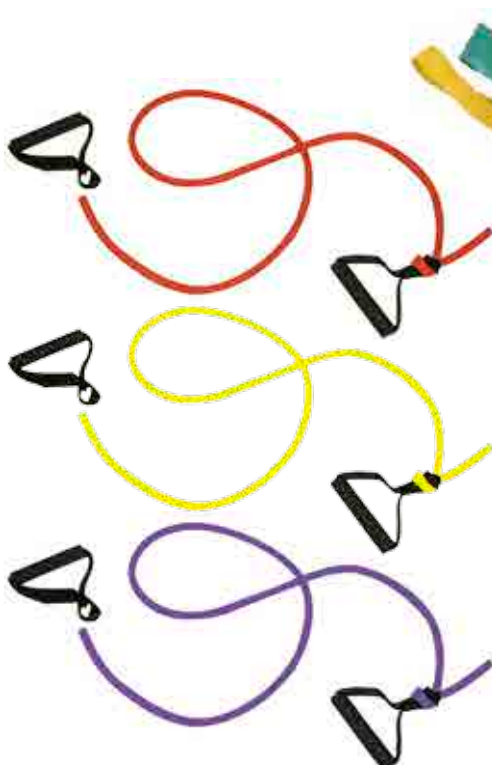

Art. 991710/ ... /991716

Elastico tubing con e senza maniglie colore rosso, giallo e viola
 Elastic with and without handles red, yellow and violet color



pg.10

Art. 991707/ 991708/ 991709

SET 5 ELASTICI AD ANELLO
 colore giallo (morbido) - rosso (medio) verde (resistente) Ø cm. 27,50
 Elastic Rings yellow (soft) - red (medium) green (hard) 27,5 cm. Ø

New!



Art. RLEF Rotolo lattice fucsia per esercizi muscolari,
 larghezza cm. 15, lunghezza m. 25 spessore 0,3 mm.

Elastic fuchsia Band for muscle exercises, 15 cm. wide, 25 meter long, 0,3 mm. thick



Art. RLEG

Rotolo lattice giallo per esercizi muscolari,
 larghezza cm. 15, lunghezza m. 25 spessore 0,5 mm.

Elastic yellow Band for muscle exercises, 15 cm. wide, 25 meter long, 0,5 mm. thick



Art. AE
Banda elastica Antonelast per esercizi di stretching e potenziamento muscolare

Elastic band for body muscle exercises



Con velcro cucito su entrambe le estremità
with velcum seamed at both sides



Art. RA
Rinforza abduttori

Elastic band for abductor muscles

Con velcro cucito su entrambe le estremità
with velcum seamed at both sides



pg.9

pg.10



Art. OSI

Over Speed Improver Tramite questa cintura elastica, l'atleta più veloce trascina il più lento, incrementando contemporaneamente la velocità di entrambi

By this elastic belt the quicker player pulls the slower player, increasing both athletes' speed

Con velcro cucito su entrambe le estremità
with velcum seamed at both sides



Art. PSR
Power Speed Resistor
per potenziamento della corsa
esercizio in coppia (nylon non elastico)
To improve explosive force - two people involved (non elastic band)



Art. EPW
Elastic Power
2 Fasce con Cintura in pelle
Incrementa la forza esplosiva potenziando la muscolatura delle gambe e del dorso
2 Bands + leather belt for explosive strenght improvement, for leg and back muscle training



Cintura elastica
Elastic belt

Art. SRE
Speed Reaction
Allenamento dei riflessi e della reattività
(l'elastico non si sgancia se il difensore perde contatto dall'attaccante)
Reflex and reactivity training device (the belt does not separate if the defender loses contact)



Cintura non elastica
Non elastic belt

Art. EB
Evasion Belt - Allenamento dei riflessi e della reattività ideale per marcature a uomo
(la cintura si sgancia se il difensore perde contatto dall'attaccante)
Reflex and reactivity training device, for man to man coverage (the belt separates if the defender loses contact)



Art. RIM

Reaction Improver
per allenamento alla reazione allo stimolo visivo in percorsi ad ostacoli, ideale per marcature a uomo
(l'elastico si stacca se si perde contatto)
Elastic Belt for visual reflex training in drill sections, for man to man coverage (the elastic separates if following athlete loses contact)



● pg.9 ● pg.10



Art. KAP Kit allenamento portiere Goal-Keeper training Kit, composto da: 10 Antonelast, 1 Cintura, 1 Rinforza abduttori, 4 Anelli fissa bande
made of 10 Antonelast, 1 Belt, 1 Abductor muscle band, 4 connecting rings - per il miglioramento della forza esplosiva
to improve explosive muscular strength and goal keeper's jumps and dives



Art. KAT Kit allenamento tattico, composto da : 7 bande elastiche di metri 10 cadauna
Tactic training Kit, made of 7 Elastic bands 10 meter long each





Art. 995238V/995239V/995240V
Barra in alluminio con bande elastiche gialle (soft)/blu (medium)/verdi (hard) impugnature in neoprene e maniglie morbide
 Aluminium Bar with yellow (soft)/blue (medium)/green (hard) elastic bands, neoprene soft handles

pg.10



Per la riabilitazione delle spalle è fondamentale continuare a lavorare in casa dopo la sessione di fisioterapia: rinforza spalle e sistema cingolare si possono infatti usare dietro una normale porta senza causare danni

pg.9



Art. AKHF

Kit Home Fitness comprendente rinforza spalle, sistema carrucolare, bastone estensibile, Antonelast uomo, Antonelast donna

Kit includes shoulder strenghtener, extensible stick, Antonelast for man and Antonelast for woman



pg.9



Art. ARS.3 Banda Elastica rinforza spalla - può essere usata in ogni luogo che abbia un appiglio per la chiusura a velcro oppure anche in casa o in albergo, grazie alla presenza di un nottolino che a porta chiusa non fa scivolare l'attrezzo e non danneggia la porta.
 Elastic Band for shoulder injury training exercises

Art. P21016 Pallina gr. 200 con elastico cm. 120 e moschettone - per riabilitazione della spalla
 200 gr. ball with 120 cm. elastic for shoulder injury recovery exercises

Art. ACD.09

DVD illustrativo per esercizi con bande elastiche, slitta, calcio tennis, sagome morbide, head jump tester
 DVD about exercises with elastic bands, sledge, soccer tennis kit, soft dummies, head jump tester (in Italian language)



Art. SC010

OFFERTA KIT TECNICO SCUOLA CALCIO

Kit così composto: n.15 Paletti slalom Art.007

**n. 15 basi ad imbuto Art.018 - n. 1 kit delimitatori Art.016 - n. 6 ostacoli over cm.12 Art.80.12
n. 2 ostacoli over cm.20 Art.80.20 - n. 2 ostacoli over cm.30 Art. 80.30 - n. 2 over cm.40 Art.80.40
n. 12 corde salto Art.043P - n. 1 Scala a pioli Art. SL4 - n. 12 Maxidelimitatori h.cm.28 Art.019.1
n. 12 cerchi piatti diam.cm.50 Art.CNP50 - n. 1 Tavoletta propriocettiva in ABS Art.168PC**

SOCCKER SCHOOL KIT SPECIAL OFFER

**15xArt.007 + 15xArt.018 + 1xArt.016 + 6xArt.80.12 + 2xArt.80.20 + 2xArt.80.30 + 2xArt.80.40
+ 12xArt.043P + 1xArt.SL4 + 12(pieces)xArt.019.1 + 12xArt.CNP50 + 1xArt.168PC**



FITNESS BODY-BUILDING

Art. S01108

Art. S01106



Art. S01108
Spalliera Svedese
a 2 campate
dim.180x250 cm.
in faggio evaporato
Swedish Wall Bar
2 spans

pg.12

Art. S01106
Spalliera Svedese a 1 campata
dim. 90x250 cm.
in faggio evaporato
Swedish Wall Bar 1 span



Art. S00908
Panca per addominali imbottita
agganciabile a spalliera
Abdominal bench to be fixed to
Swedish Wall Bar



Art. UNG05 / UNG1 / UNG2 / UNG3 / UNG4 / UNG5
Coppia Manubri da Kg. 0,5, 1, 2, 3, 4, 5 cadauno
Pair of Dumb Bells, from 0,5 to 5 Kg. each bell

pg.11



Art. F301
Porta manubri in ferro
Dumb Bell Rack



Art. 17222
Cintura Body Building misure da XS a XL
Body Building Leather Belt
sizes from XS to XL

pg.10

*Fermadischi a vite inclusi

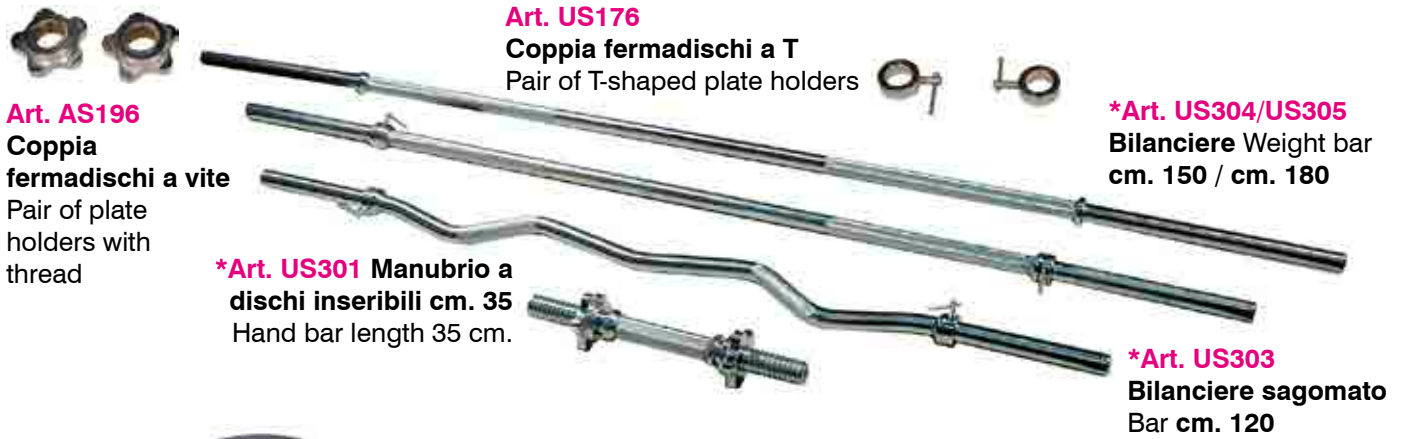

Art. AS196
Coppia fermadischi a vite
Pair of plate holders with thread

Art. US176
Coppia fermadischi a T
Pair of T-shaped plate holders

***Art. US304/US305**
Bilanciere Weight bar
cm. 150 / cm. 180

***Art. US301** Manubrio a dischi inseribili cm. 35
Hand bar length 35 cm.

***Art. US303**
Bilanciere sagomato
Bar cm. 120



Art. UN640
Dischi in ghisa
Kg. 0,5 - 1 - 2 - 5 - 10
15 - 20 cadauno
Cast Iron Weight Plates



Art. UN640P
Dischi in ghisa rivestiti in gomma
Kg. 0,5 - 1 - 2 - 5 - 10 - 15 - 20 cadauno
Cast Iron Weight Plates covered with rubber



Art. US287
Coppia fermadischi a molla
Pair of spring plate holders

pg.10



Art. F302
Porta dischi in ferro
Weight Plates Rack



Art. 17203
Paio guanti Lycra
misure da XS a XL
Gym Gloves lycra



Art. 30907
Paio guanti spugna spandex
misure da XS a XL
Gym Gloves in spandex foam



Art. 13382 / 13383 / 13384 / 30937 / 13385
Paio Cavigliere, Kg. 0,5 - 1 - 1,5 - 2 - 2,5 cadauna
Pair of Ankle Weights 0,5 - 1 - 1,5 - 2 - 2,5 Kg. each one



Art. E805
Paio Cavigliere, Kg. 2,5 cadauna con pesi estraibili
Pair of Ankle Weights 2,5 Kg. each removable weights

pg.11



Art. 9939 - Barra Entroporta - Door Bar



Art. 9941
Coppia maniglie per flessioni
Push-up handles



Art. C3005
Paio di Cavaliere Antigravitazionali
Pair of Gravity Boots



Art. 29920
Coppia Tenaglie
stringimano con spugna



Art. 29922
Barra elastica Power Spring



Art. E680
Bracciale
porta oggetti
in neoprene
Neoprene arm wallet

pg.11



Art. 18142
Estensore
con elastici
Chest-Expander



Art. 74404A
Contapassi
Step Counter



New!

Art. E7350
Contapassi multifunzione
Multi-functions Step Counter

pg.12



Art. 31362A
Cardiofrequenzimetro
Sportline
solo Finger touch
(senza fascia toracica)
Heart pulse Sportline
multi-functions
Finger touch



Art. FT1.P
Cardiofrequenzimetro
Polar FT1: frequenza
cardiaca in bpm,
target zone manuale,
orologio, cronometro
trasmissione segnale
codificata
con fascia toracica
Heart pulse Polar FT1
multi-functions



Art. 13632A
Ministepper
 Tensione a pistoni idraulici non regolabile. Computer a 3 funzioni: tempo, numero steppate, calorie.
 Peso massimo utilizzatore 100 Kg.
 Peso dell'attrezzo 8 Kg.
 Ministepper with hydraulic rams



Art. 30087
Stepbench regolabile a 2 altezze (altezza massima cm. 21)
 con superficie antiscivolo dim. cm. 72x38
 Step adjustable at 2 different heights (maximum height 21 cm.)
 with anti-skid surface dim. 72x38 cm.

Art. OCST
Gradino step a 2 altezze (10-15 cm.) con antiscivolo dim. cm. 68x30
 Step 2 heights (10-15 cm.) with anti-skid dim. 68x30 cm.

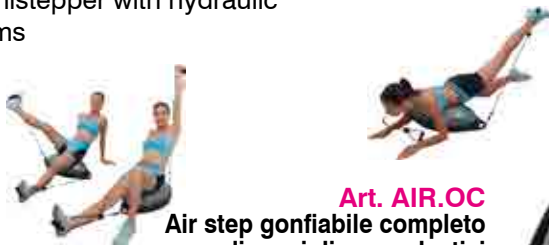

Art. AIR.OC
Air step gonfiabile completo di maniglie con elastici
 Inflatable Air Step handles and elastics included

pg.11

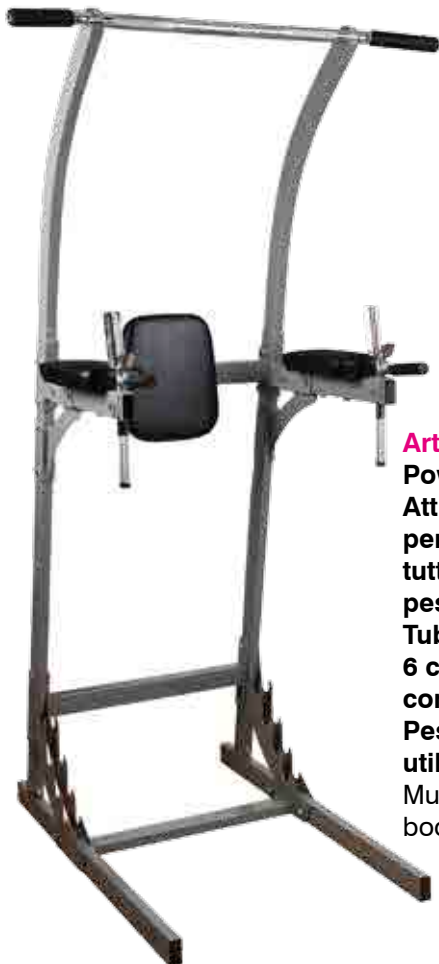

Art. 00462A
Power Tower
 Attrezzo multifunzione ideato per l'allenamento intensivo di tutto il corpo senza l'utilizzo dei pesi - 10 esercizi praticabili Tubolare a sezione rotonda da 6 cm. - Cuscini ad alta densità con spessore di 5 cm.
 Peso massimo utilizzatore 120 Kg.
 Multi purpose tool for intensive body training without weights

pg.12



Art. 352.661
 Stepper con appoggio, struttura a tubo ovale diametro 6 cm. chiudibile Pistoni a 12 regolazioni.
 Computer a 5 funzioni: tempo, calorie, numero di steppate totali e al minuto, pulsazioni con sensore hand pulse ruote per il trasporto
 Peso max utilizzatore 100 kg.
 Peso dell'attrezzo 30 Kg.
 Stepper with hand supports



Art. 61.967
Panca multifunzione
telaio in acciaio,
schienale regolabile
dim. cm. 132x32x91
portata massima kg. 100
Weight lifting Bench

ATTENZIONE: questi prodotti sono concepiti esclusivamente per uso home fitness, perciò la garanzia non copre il loro utilizzo presso palestre o centri sportivi

Art. 63.968
Panca pesi con supporti
bilanciere, telaio in acciaio,
schienale regolabile
dim. cm. 153x70x117
portata massima kg. 100
Weight lifting Bench
with bar holders



Art. 20462A
Panca piana/90°
Power Bench
rinforzata
(abbinabile con
Power Rack)



Art. SPR10
Power Rack

Supporti per bilanciere (bilanciere non incluso)
Altezza regolabile in 6 posizioni con pratici supporti
Tubolare a sezione rotonda da 6 cm.
Dotato di 2 rimessaggi per dischi completi di riduttore
olimpionico da 50 mm e di sicure per il bilanciere
Peso massimo caricabile 165 Kg.
Supports for weight bar

pg.12



Art. IS580

Stazione Multifunzione
Dotata di torre per dorsali, pressa per
pettorali, attrezzo per le gambe, vogatore,
cuscino per bicipiti - carico massimo 60 Kg.
15 esercizi praticabili
Peso massimo utilizzatore 120 Kg.
Multi purpose machine



Art. 729761
Panca a inversione chiudibile
Schienale rigido imbottito
Maniglie e fettuccia per il bloccaggio e per agevolare il recupero della posizione iniziale
Regolabile secondo l'altezza dell'utilizzatore: minima cm. 147, massima cm. 198
Peso max utilizzatore 100 Kg.
Inversion Bench

pg.12



Art. ABK
Panca per addominali chiudibile con maniglione per l'appoggio delle braccia regolabile.
Schienale regolabile in 5 posizioni.
Bloccaggio per le caviglie regolabile in 3 posizioni
peso massimo utilizzatore 100 kg.
Bench for abdominal muscle training

Art. 58.967
Panca per addominali chiudibile
dim. cm. 131x32x57
portata kg. 100
Bench for abdominal muscle training



ATTENZIONE: questi prodotti sono concepiti esclusivamente per uso home fitness, perciò la garanzia non copre il loro utilizzo presso palestre o centri sportivi



Art. IS783
AB Shaper pro



New!

Art. GWM13
Pedaliera manuale
Utilizzabile da seduti per gli arti inferiori e appoggiata sul tavolo per gli arti superiori
Peso 5 Kg. - con computer
Intensità sforzo regolabile
Cycling device for arm and leg exercises

pg.11



New!

Art. GWE13
Pedaliera elettrica per la ginnastica passiva per gli arti inferiori e superiori
Regolazione velocità motorizzata con telecomando
Peso 6 Kg. - con computer
Cycling electric device for arm and leg exercises



Art. IC111

Bici da camera con freno magnetico
Regolazione dell'intensità manuale a 8 posizioni - rapporto di cambio 1/8
Volano da 2 kg. - Computer a 7 funzioni: tempo, velocità, distanza, calorie, odometro, scan, pulsazioni con sensori Hand Pulse - Ruote per il trasporto sui piedini anteriori - Manubrio regolabile
Sella regolabile in altezza a 8 posizioni
Peso massimo utilizzatore 100 Kg.
Peso dell'attrezzo 22 kg.
Cyclette Magnetic with 7 function computer



Art. IC220

Bici da camera con freno magnetico
Regolazione dell'intensità manuale a 8 posizioni - rapporto di cambio 1/6.5
Volano da 4 kg - Computer a 7 funzioni: tempo, velocità, distanza, calorie, odometro, scan, pulsazioni con sensori Hand Pulse
Ruote per il trasporto sui piedini anteriori - Manubrio regolabile
Sella regolabile in altezza a 8 posizioni
Peso massimo utilizzatore 110 Kg.
Peso dell'attrezzo 27 kg.
Cyclette Magnetic with 7 function computer



Art. IC520

Bici da camera con freno magnetico a 8 livelli di resistenza
Volano da 4,5 kg.
Computer multifunzione: tempo, velocità, distanza, calorie, odometro, pulsazioni con sensori Hand Pulse
Manubrio regolabile
Sella regolabile in altezza
Peso massimo utilizzatore 120 Kg.
Peso dell'attrezzo 30 Kg.

Cyclette Magnetic with multi function computer, seat and handle-bar adjusting systems

pg.11



Art. IR120

Bici da camera con freno magnetico e sedile con schienale
Regolazione dell'intensità manuale a 8 posizioni rapporto di cambio 1/8,5 - Volano da 6 kg
Computer a 5 funzioni: tempo, velocità, distanza, calorie, pulsazioni con sensori Hand Pulse
Ruote per il trasporto sui piedini anteriori
Peso massimo utilizzatore 100 Kg - Peso dell'attrezzo 30 Kg.
Cyclette Magnetic with 5 function computer, seat adjusting system



Art. 18220

Coprisella spinning
Seat cover
for spinning bike



Art. 559181

PT3.5 Indoor Cycle 18 Kg.
Flywheel Bici per pratica dello spinning con volano da kg. 18 e pedalata a 2 direzioni (ruota fissa)
Sella regolabile in orizzontale e in altezza a 8 posizioni
Manubrio regolabile in altezza con appoggi per l'avambraccio
Pedali professionali in alluminio
Portaborraccia
Peso massimo utilizzatore Kg. 125
Peso dell'attrezzo 41 kg.
Cyclette Magnetic with seat and handle-bar adjusting systems



ATTENZIONE: questi prodotti sono concepiti esclusivamente per uso home fitness, perciò la garanzia non copre il loro utilizzo presso palestre o centri sportivi

Art. TFK-MAG

TAPIS ROULANT MAGNETICO TFK-SLIM-MAG
piano di corsa cm.38x102

sistema di frenaggio magnetico su 8 posizioni
doppio volano Kg.6 - peso massimo
utilizzatore Kg.100 - display LCD indicante velocità,
frequenza cardiaca, distanza, tempo,
consumo calorico, scan, rilevazione cardio hand pulse
Tapis roulant magnetic with no engine,
with multi function computer

New!

pg.12



Art. TFK-300

TAPIS ROULANT TFK-300

motore 1,75/2,75 HP DC - velocità 0,8-14 Km/h
inclinazione manuale - piano di corsa cm. 42x123
peso massimo utilizzatore 100 Kg.

1 programma libero, 12 predefiniti, display LCD
indicante velocità, frequenza cardiaca, distanza,
tempo, consumo calorico, programma in esecuzione
Tapis roulant with 1,75/2,75 hp engine and
multi program computer

New!



Art. TFK-500

TAPIS ROULANT TFK-500

motore 2,00/3,00 HP DC - velocità 0,8-16 Km/h
inclinazione elettrica - piano di corsa cm.42x132
peso massimo utilizzatore 110 Kg.

1 programma libero, 12 predefiniti, display LCD
indicante velocità, inclinazione, frequenza cardiaca,
distanza, tempo, consumo calorico, programma in
esecuzione - ricevitore wireless fascia cardio integrato
Tapis roulant with 2/3 hp engine and multi program
computer

New!

Art. TRXRC
Vogatore Rower Compact - display LCD indicante
numero vogate, calorie, tempo, scan
regolazione sforzo su 12 livelli
peso max utilizzatore 110 Kg.
Rower machine with computer



New!

CASACCHE - Mesh Shirts



Art. 088-A

Casacca traforata fluo taglia adulto

Fluo pierced Training bib adult size - colors as in the picture



Art. 088-B

Casacca traforata fluo per bambini fino a 9 anni

Fluo pierced Training bib size small, colors as in the picture



pg.14

Art. 088-D

Casacca traforata double-face fluo taglia adulto

colori rosso/blu - giallo/arancio - rosso/giallo

Fluo pierced training bib double-face adult size
colors red/blue - yellow/orange - red/yellow



Art. IRP01

Polo mezza manica personalizzabile

Polo Shirt
with your logo on request

pg.15



Art. TSG10/TSG11

T-SHIRT colori: bianco, nero, rosso, verde, giallo, arancio, blu, royal

misure: bambino dalla S alla XL adulto dalla S alla XXL, neutre oppure personalizzabili con logo ad un colore (ordine minimo per la personalizzazione 50 pezzi)

T-Shirt various colors and size, also with your logo on request (minimum order for customization 50 pieces)

PANTALONCINI - CALZE - GUANTI - CAPPELLINI Shorts - Socks - Gloves - Caps



Art. MF01

Pantaloncini da allenamento in poliestere - taglie dalla 3XS alla XXL - Colori: Royal, Bianco, Nero, Blu e Rosso con marchio Pro Touch

Shorts in polyester - size from 3XS to XXL - Colors: Royal, White, Black, Navy and Red



Art. TOS1

**Scaldacollo in pile
taglia unica regolabile**
Neck warmer in pile
one size fits all



Art. IS005

Paio calze calcio con piede
Taglie Junior (35/38),
M (39x42), L (43x46)
Colori: Bianco, Rosso, Royal, Navy,
Nero, Granata, Verde, Giallo
Pair of soccer socks
Sizes: JR., M and L
Colors: white, red, royal,
blue, black, brown, green, yellow



Art. TOGA

**Guanti acrilico elasticizzati
con antiscivolo - colore nero**
misura junior e senior
Black Elastic acrylic Gloves
with antiskid
size junior and senior



pg.15

Art. TOBA

Berretto in acrilico nero
taglia junior e senior
Winter black Cap
size junior and senior

Art. IR6013

**Berretto in acrilico,
vari colori con ricamo**
Winter Cap with logo
in different colors



pg.14

Art. PLVFC

**Paio laccini bianchi
ferma calze con velcro**
Pair of white stop stockings with velcum



Art. IDNC38

Nastro adesivo colorato ferma calze
cm. 3,8x13,7 mt.
colori : rosso, nero, blu, verde e giallo
Color Tape stop stockings
red, blue, black, green, yellow

New!

Art. IRCP
Cappellino 6 spicchi
Baseball,
compreso ricamo
minimo 50 pezzi
Baseball caps



pg.14

Art. 07761A

Giacca pioggia con marsupio
taglie dalla XXXS alla XXL
colori: navy, rosso e nero
Rain Jacket - sizes XXXS to XXL
colors: blue, red and black

Art. SB099

TUBOLARE BARRET in microfibra 108 dinari

Prodotto tecnico brevettato come modello d'uso CEE - Made in Italy

Lascia traspirare la pelle e ripara dal freddo e dal vento

utilissimo in molteplici situazioni:

durante e dopo gli allenamenti, durante gli incontri, per sostenere la tua squadra, nel tempo libero, in moto etc.

Barret TUBOLAR HAT in microfiber - made in Italy patented
BTH lets your skin breath while protecting you from cold and wind
you can wear it during or after training, during the game, in your spare time,
to support your team, when riding your bike etc.

utilizzabile come scaldacollo, foulard, bandana, fascia, passamontagna etc.



it can change shape from neck warmer to head band to foulard to bandana

**PRODOTTO
TECNICO**
**TECHNICAL
PRODUCT**



**A differenza del comune
prodotto in pile, la
microfibra del Tubolare
Barret impedisce il
surriscaldamento e
l'eccessiva sudorazione
della pelle, grazie
alla sua speciale
traspirazione e
leggerezza**

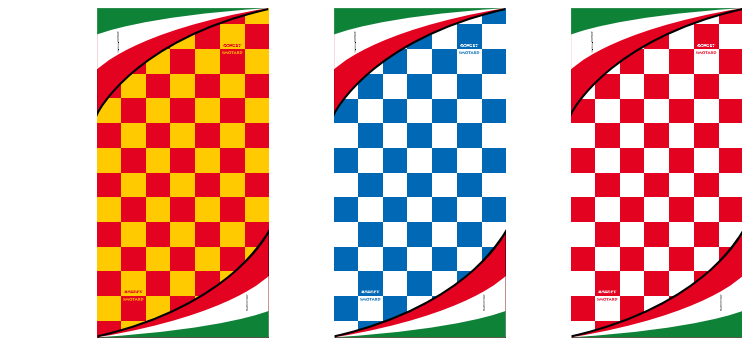
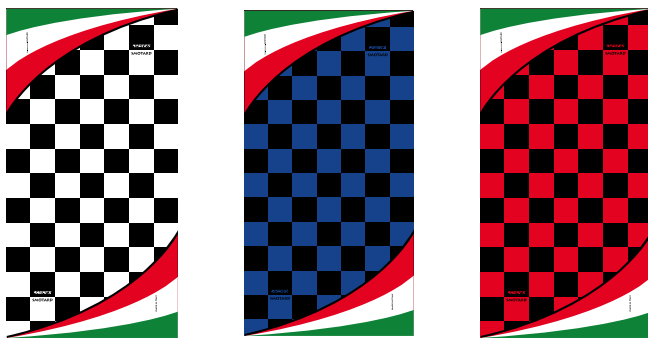

**Colori disponibili:
bianco/nero, nero/azzurro,
rosso/nero, bianco/celeste,
bianco/rosso, giallo/rosso,
azzurro nazionale italiana
(prodotto personalizzabile su
richiesta per ordine minimo di
100 pezzi, con spese
per elaborazione grafica da
definire)**

Colors available
as in the pictures
Barret tubolar HAT can be
personalized with your logo and
colors with a minimum order of
100 pieces (graphic work not included in the price)



**NUMERAZIONI
TERMOALDABILI
NUMBERS
FOR UNIFORMS**

Colori disponibili:
bianco, giallo,
rosso, verde, royal,
blu, granata, nero,
oro, argento
Available colors :
white, yellow, red,
green, royal, blue,
brown, black, gold,
silver

● pg.15

Art. PG23
Numeri termosaldabili
Serie Omega h.23 cm.
in confezione blister da 1 a 22
Numbers for sport uniforms
Omega series 23 cm. height
package from number 1
to number 22

Art. PG18
Numeri termosaldabili
Serie Omega h.18 cm.
in confezione blister da 1 a 15
Numbers for sport uniforms
Omega series 18 cm. height
package from number 1
to number 15

Art. PG10
Numeri termosaldabili
Serie Omega h.10 cm.
in confezione blister da 1 a 22
Numbers for sport uniforms
Omega series 10 cm. height
package from number 1
to number 22

Art. PN23
Numeri termosaldabili
Serie Omega h.23 cm.
numeri singoli (da 0 a 9)
Single numbers for sport uniforms
Omega series 23 cm. height
(from 0 to 9)

Art. PN18
Numeri termosaldabili
Serie Omega h.18 cm.
numeri singoli (da 0 a 9)
Single numbers for sport uniforms
Omega series 18 cm. height
(from 0 to 9)

Art. PN10
Numeri termosaldabili
Serie Omega h.10 cm.
numeri singoli (da 0 a 9)
Single numbers for sport uniforms
Omega series 10 cm. height
(from 0 to 9)



Art. PG4
Numeri termosaldabili Serie Omega
h.4 cm. in confezione blister numeri da 1 a 100
colore bianco o nero
Numbers for sport uniforms
Omega series 4 cm. height
package from number 1 to number 100
black or white color



Art. PP023
Profilo perimetrale in poliестere colorato
per numeri Omega 23 da 0 a 9
(per ottenere numeri bicolore con doppia pressata)
Color Frame for Omega 23 numbers from 0 to 9
to create bi-color numbers (assorted colors)

PARASTINCHI - Shinguards

Art. IS30HS

Paio parastinchi senza cavigliera misura S-M-L
Pair of shinguards without ankle protection size S-M-L

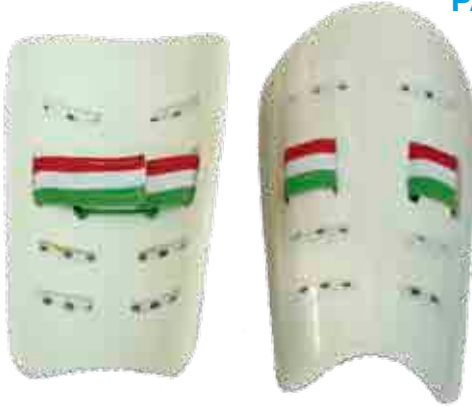

Art. PSCV

Paio parastinchi senza cavigliera misura adulto e bambino
Pair of shinguards without ankle protection junior and senior size

**PARASTINCO BARRET INNOVATIVO REALIZZATO CON SPECIALI LISTELLI ANATOMICI
LEGGERRISSIMO MA CON ALTA RESISTENZA ALL'IMPATTO**
VERY SPECIAL SHINGUARDS anatomic, very light and highly resistant to impact

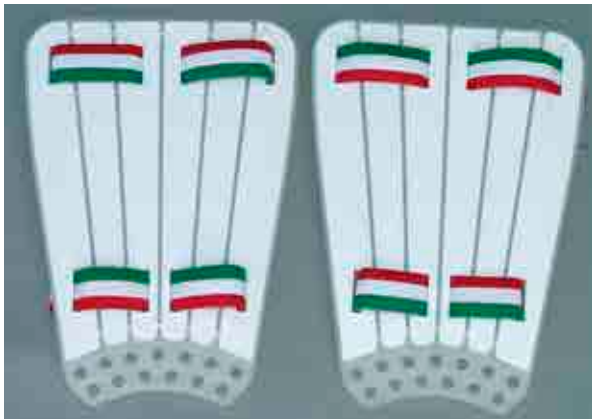

pg.14



Art. BP90

Paio parastinchi Barret senza cavigliera misura unica
Pair of Barret shinguards without ankle protection one size fits all



**BREVETTATO
PATENTED**



Art. PBC

Paio parastinchi con cavigliera misura adulto e bambino
Pair of shinguards with ankle protection senior and junior size



FASCE CAPITANO - GUANTI PORTIERE - Captain's Armbands - GK Gloves



Art. 150
Fascia capitano elastica
misura adulto
Elastic Captain's armband
size adult

Art. 150.B
Fascia capitano elastica
misura bambino
Elastic Captain's armband
size children



Art. 150F Fascia capitano elastica mis. adulto
colore giallo o arancio fluo
Elastic Captain's armband adult size
colors: fluorescent yellow and orange

pg.16



Art. 150V-150V.B
Fascia capitano con velcro, taglia adulto o bambino
Modello Champions colori bianco, rosso, giallo, verde,
blu, fucsia, arancio e rosa - h. cm. 6,5
Captain's armband adjustable length - 6,5 cm. height
size adult or children
colors: white, red, yellow, blue, green,
fuchsia, orange and pink



Art. 150V.9
Fascia capitano con velcro, taglia adulto
colori: bianco, rosso, giallo fluo, verde,
blu e arancio fluo - h. cm. 9
Captain's armband adjustable length - 9 cm. height
size adult - colors: white, red, fluo yellow,
blue, green, fluo orange

pg.14



Art. 1000PG
Paio Guanti
portiere misure
da 5 a 11
Pair of Goal Keeper Gloves
Size from 5 to 11

I colori dei guanti
nelle foto
possono variare



Art. F30BG
Paio Guanti portiere junior misure da 4 a 8
Pair of Goal Keeper Gloves
Size from 4 to 8

TACCHETTI ED ACCESSORI PER SCARPE - Studs and Shoe accessories



Art. 265 Bis / 268 Bis / 270 Bis

Tacchetto alluminio conico mm. 14-17-19
Conical aluminium stud, 14-17-19 mm.



Art. 262/263/264/265/266/267/268/269/270

Tacchetto alluminio conico tornito
Milled Conical aluminium stud
mm. 11, 12, 13, 14, 15, 16, 17, 18, 19



Art. PR11 / PR14 / PR17

Tacchetto alluminio conico tornito punta rinforzata mm. 11-14-17
Conical aluminium Studs reinforced tip 11-14-17 mm.



● pg.12

● pg.13

Art. A11 / A13 / A15 / A17

Tacchetto alluminio conico tornito argentinos superleggero serie A
mm. 11-13-15-17
Conical milled aluminium Studs ultra-light Serie A 11-13-15-17 mm.



Art. 292 / 293 / 294 / 294 Bis
mm. 11, 13, 15, 17

Tacchetto in nylon conico punta rinforzata in alluminio
Conical Nylon stud with reinforced tip



Art. 35M12 / 35M14

Tacchetto gomma base stretta mm. 12 / 14
Narrow Base Rubber Stud mm. 12 / 14



Art. 072.11/ 072.13

Tacchetto gomma base larga per terreni gelati mm. 11 / 13
Wide Base Rubber Stud - for icy ground



Art. 302 Base filettata in alluminio
mm. 7, 8, 10, 12

Art. 302G Base filettata in alluminio
mm. 13, 14, 17

Threaded aluminium bases

Art. 314 Rondella in alluminio - Aluminium washer



Art. CHAZ
Chiave in acciaio zincocromata
Stud Key



Art. 317 / 318
Paio tendiscarpe a molla,
misura 39-42 / 43-46
Shoe stretchers with spring,
size 39-42 / 43-46

pg.13

Art. BLS4
Lastrina antitrauma ritagliabile in gel forata
spessore mm.4 dimensioni cm.14x28
da utilizzare a contatto con la pelle del piede
dentro la scarpa in caso di ferite, vesciche o
contusioni: attutisce il dolore derivante dalla
corsa e dall'impatto con la palla
Anti-shock pierced Gel thickness 4 mm. size
cm.14x28 you can cut it and place it inside your
shoe against the skin to prevent pain from running
and kicking in case of small foot injuries



pg.14



Art. 326 / 327 / 328
Paio lacci per scarpe neri e bianchi cm. 120-150-180
Pair of black and white shoe laces 120-150-180 cm. long

pg.14



Art. 64071A
Paio solette in gel
Gel Insoles

Art. 21654
Paio solette
Spugna Sport
Sport Insoles



Art. E6694
Paio Alzatacco in silicone
misura S (33/36) - M (37/40)
L (40/44) - XL (44/48)
Silicone under Heel softeners
various sizes



pg.14

Art. 238.1
Grasso Aquila Kg.1
 Aquila Grease for shoes
 Kg. 1

Art. 238
Grasso Aquila ml. 100
 Aquila Grease for shoes
 ml. 100



Art. S489
Spazzola
in setola naturale
 Shoe Brush



Art. 05071A
Spugna lucidante
 Polishing sponge

pg.13



Art. 34071A
Spray
impermeabilizzante
 Spray waterproofing



Art. 44071A
Spray
deodorante
 Spray deodorant



Art. 25071A
Spray
detergente
 Spray cleaner



Art. D122X
Spray Dilato ml. 200
ammorbidente
 Spray to soften leather
 soccer shoes



GRANDE RISPARMIO
D'ACQUA!
 Great water saving!

pg.14

Art. FA270
Macchina lavascarpe con 4 spazzole sostituibili
getti incrociati regolabili ad alta pressione
completo di poggiamani e 4 fori di fissaggio a terra
in dotazione fascetta in acciaio per collegamento tubo
mm 15x21 (non incluso) alla rete idrica.
 Shoe washing device - high pressure crossed water jets
 iron frame with handles - replaceable brushes
 easy fixing to the floor with 4 holes

New!



MATERASSINI - Mats

Art. 044
Materassino pieghevole
alta densità
cm. 180 x 50 x 0,7
Folding foam Mat
high density
cm. 180 x 50 x 0,7

Art. 044-A
Materassino pieghevole
alta densità
cm. 180 x 60 x 0,7
Folding foam Mat
high density
cm. 180 x 60 x 0,7

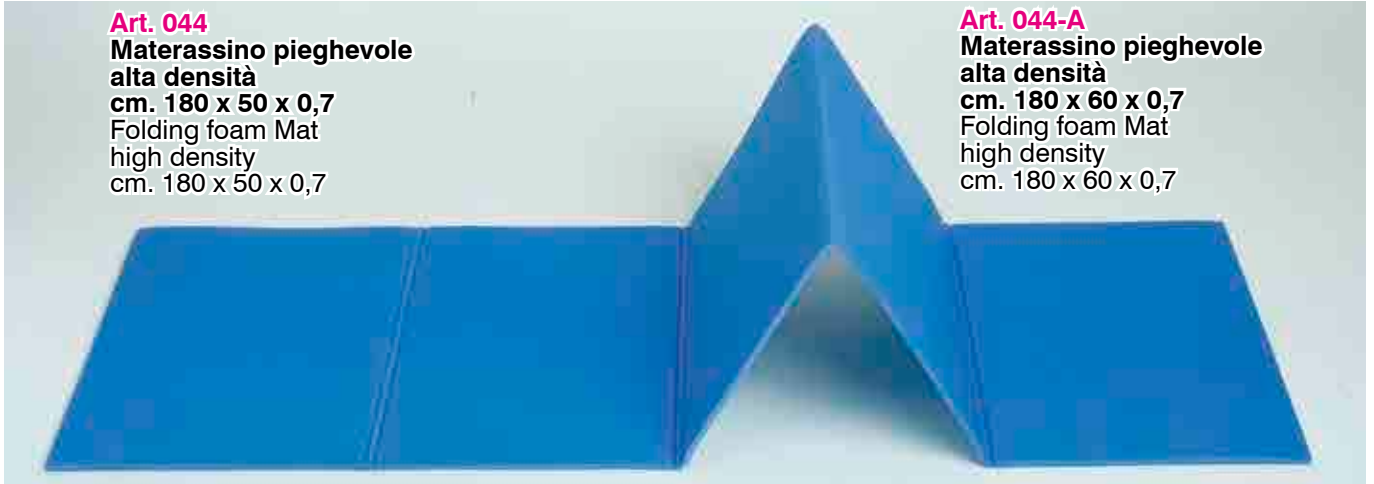

pg.15

pg.16

Art. 044-R
Materassino arrotolabile
alta densità
cm. 180 x 50 x 0,6
Rolled foam Mat
high density 180 x 50 x 0,6 cm.



Art. AS803
Materassino exercise longer mat
imbottito e serigrafato cm.180x60x2,5
PVC Mat 180x60x2,5 cm.



Art. 30924
Materassino arrotolabile Yoga
cm. 172x60x0,4
Rolled Yoga Mat 172x60x0,4 cm.

LAVAGNE TATTICHE - Tactic Boards

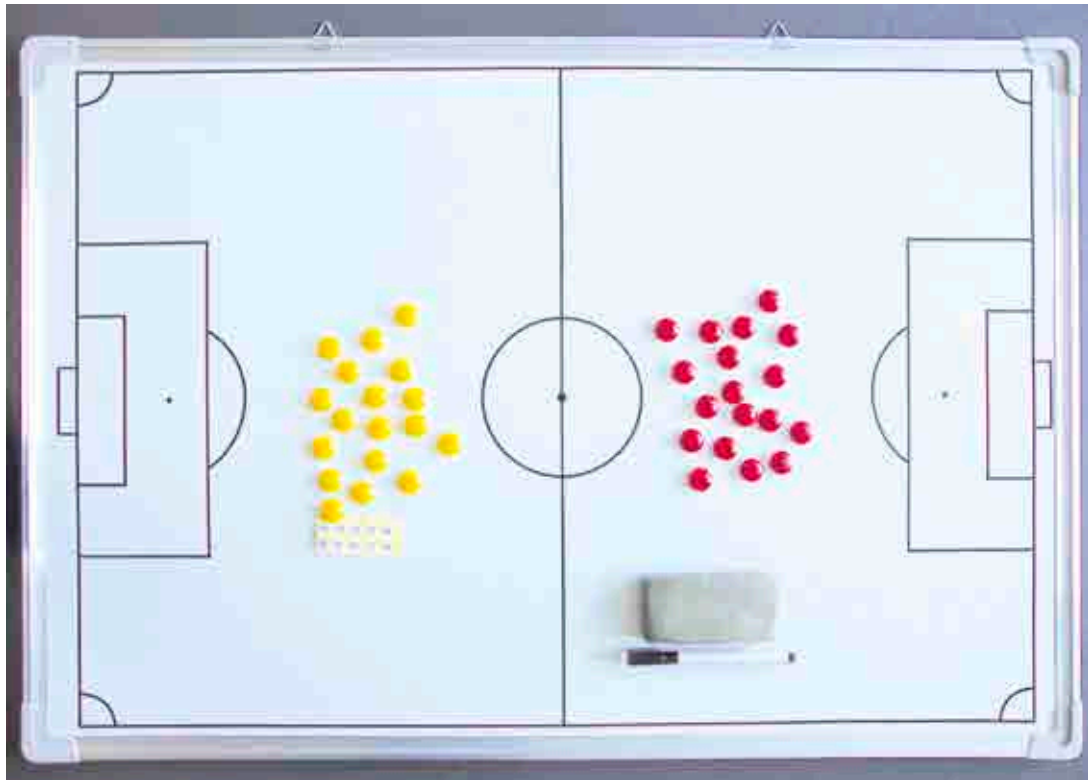

pg.17

Art. 087
Lavagna magnetica
cm. 60x90 cancellabile
con cornice metallica
Tactic board 60x90 cm.
magnetic and erasable with
metal frame

Art. 089-P
Lavagna
magnetica
cancellabile
pieghevole
cm. 46x25
Foldable
Tactic Board
magnetic
and erasable
46x25 cm.



Art. 089-P

Lato A
Side A

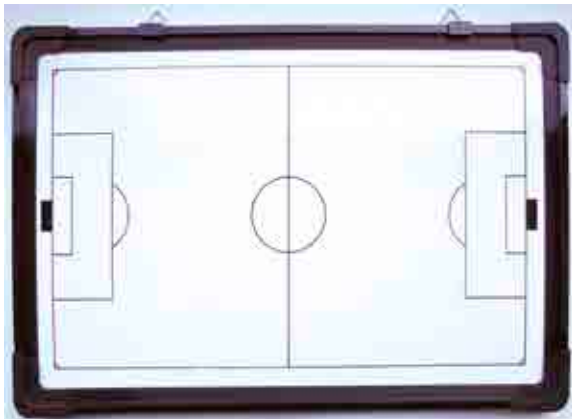

Lato B
Side B

Art. 089
Lavagna magnetica bifacciale cancellabile
con borsa cm. 45x30
2 face Tactic Board magnetic and erasable
45x30 cm. with bag



Lato A
Side A



Lato B
Side B

Art. 089-A
Lavagna bifacciale
cancellabile cm. 40x23
2 face Tactic Board
erasable, 40x23 cm.



Art. 18330

Lavagna magnetica cancellabile pieghevole Multisport (Calcio, Basket, Volley, Rugby, Badminton, Tennis, Floorball etc.)
dimensioni cm. 32x22
Multisport Foldable Tactic Board magnetic and erasable 32x22 cm.



Art. PAL-B

Pal Block - Blocco tascabile con 25 pagine copertina cancellabile
Pocket Block notes
25 pages with erasable cover



Art. 089CF

Lavagna Tattica Calcio monofacciale cancellabile cm. 40x23 (disponibile fino ad esaurimento scorte)
Futsal Tactic Board 40x23 cm. erasable (until available in stock)



Art. PM

Serie pedine magnetiche di ricambio
Spare magnetic pieces for tactic boards

(pg.17)

Lato A
Side A

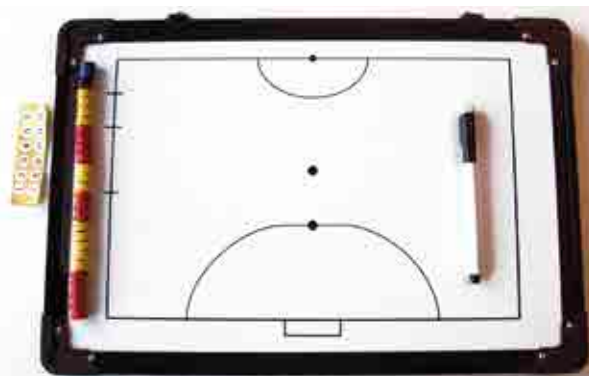
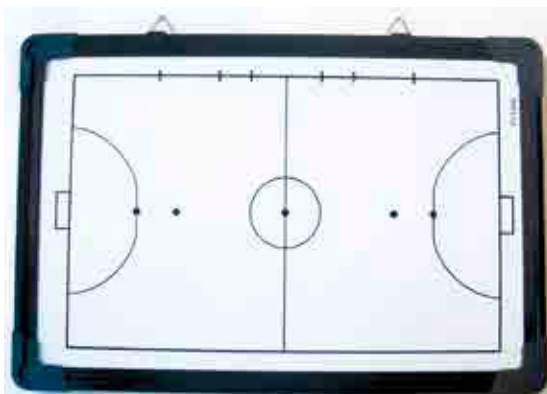

Lato B
Side B

Art. 089CM

Lavagna Tattica Calcio bifacciale magnetica e cancellabile cm. 45x30
2 face Futsal Tactic Board magnetic and erasable 45x30 cm.

Lato A
Side A

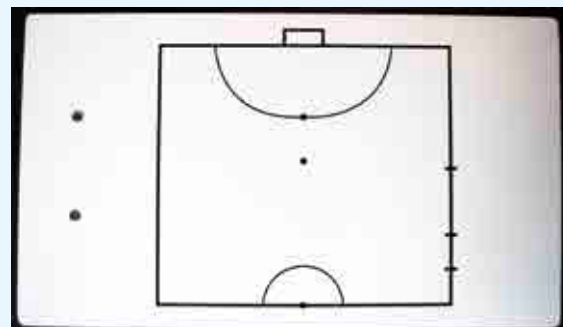
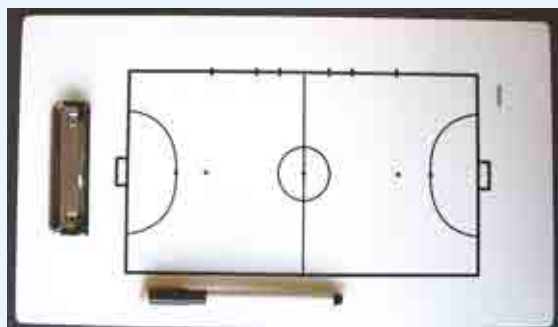

Lato B
Side B

Art. 089-C

Lavagna Tattica Calcio bifacciale cancellabile cm. 40x23
2 face Futsal Tactic Board 40x23 cm. erasable



Art. 164
Ghiaccio spray
ml. 400
Ice spray 400 ml.

Art. 165
Ghiaccio
in busta monouso
Ice in envelope

GHIACCIO - TAPE - CREME - OLI
Ice - Tape - Creams - Oils



Art. NE2.5
Nastro economico 2,5x14 mt
Tape 2.5x14 mt.

Art. NE5
Nastro economico 5x14 mt
Tape 5x14 mt.

Art. N2.5
Nastro tipo strappal 2,5x10 mt
Tape strappal 2,5x10 mt.

Art. N5
Nastro tipo strappal 5x10 mt
Tape strappal 5x10 mt.



pg.16

Art. 9254
Salvapelle
Skin Protection

New!



Art. IDNC38
Nastro adesivo colorato fermacalze
cm. 3,8x13,7 mt.
colori : rosso, nero, blu, verde e giallo
Color Tape stop stockings
in red, black, blue, green and yellow



Art. TPG09
Fraplast cm. 8
(Tensoplast)



Art. IPT02
Forbice
taglia taping
in acciaio inox



Art. IPT01
Cutter taglia
bendaggi



Art. ONC
Olio riscaldante 500 ml
stimola la circolazione,
tonifica la muscolatura,
previene le lesioni muscolari
microtraumatiche
Oil 500 ml
for muscle warm up, stimulating
blood circulation
and preventing micro injuries



Art. CNC
Crema riscaldante 250 ml
stimola la circolazione,
tonifica la muscolatura,
previene le lesioni muscolari
microtraumatiche
Cream 250 ml
for muscle warm up, stimulating
blood circulation and preventing
micro injuries



Art. IRVF
Vasellina filante
per curare le zone della pelle a
maggiore sollecitazione
Vaseline avoiding skin problems



Art. IRFA
Fango argilla per impacchi
dopo distorsioni,
per assorbimento ematomi
Special mud to be used after
injuries (i.e. sprained ankles)
and to absorb bruises

pg.16

pg.17



Art. IJGE
Crema Jel Gestic
coadiuvante per
infiammazioni, contusioni
e lesioni dell'apparato
muscolare
Cream Jel Gestic
for treating minor injuries
and sore muscles



T10R
GEL
FREDDO
refrigerante
immediato su
contusioni o
strappi muscolari
Cold Gel for
immediate
application on
bruises and sore
muscles

T17G
CUSCINETTO
IN GEL
dim. cm.17x27
(effetto freddo
ed effetto caldo)
Gel Pillow
17x27 cm.
(both for cold
and hot therapy)

T17G

BORRACCE - Water Bottles



Art. 308
Borraccia da 1 litro
1 liter Water Bottle

Art. 306
Kit 6 Borracce da 1 lt. con cestello
Kit 6 one liter water bottles with holder



Art. 308.C
Cestello per 6 borracce in plastica
Holder for 6 water bottles in plastic



Art. B500ML
Borraccia da 1/2 litro
1/2 liter Water Bottle

pg.16

Art. K8S6
Kit 8 Borracce da 1 lt. con cestello (modello 2010)
Kit 8 one liter water bottles with holder (2010 model)



Art. K8
Borraccia da 1 litro (modello 2010)
1 liter Water Bottle (2010 model)



Art. OC8
Cestello per 8 borracce in plastica pieghevole (modello 2010)
Foldable Holder for 8 water bottles in plastic (2010 model)



BANDIERINE - Flags



Art. 074
Kit completo
4 paletti
calcio d'angolo
con snodo
(bandierine colore
giallo o rosso)
Kit 4 complete
flexible Corner
Poles
yellow or red flags



pg.17

Art. 368 Set ricambi
4 Bandierine calcio d'angolo
colore giallo o rosso
Set of 4 spare Corner Flags
yellow or red color

Art. 073 Kit completo
4 paletti calcio d'angolo
(bandierine colore giallo o rosso)
Kit complete 4 Corner Poles
(flag color yellow or red)



Art. 075 / 076
Coppia Bandierine guardalinee
gialle o a scacchi
Pair of linesman's Flags
yellow or checked



Art. 075

Art. 076



Art. 367-G

Art. 367-S

Art. 367-G / 367-S
Coppia ricambi
Bandierine
guardalinee
gialle o a scacchi
Pair of spare
linesman's Flags
yellow or checked



Art. 13ALC
Coppia Bandierine guardalinee
a scacchi fluorescenti
con asta in alluminio e custodia
Pair of linesman's Flags
fluorescent with aluminium stick
and holder



Art. 172
Coppia Bandierine
guardalinee
elettroniche
complete
di ricevitore
e valigetta

Pair of electronic linesman's Flags
complete with signal
receiver and case

ACCESSORI ARBITRO - Referee's accessories



Art. 078
Fischio Fox 40 Classic senza pallina
nero o colorato
Whistle Fox 40 Classic



078PD
Fischio arbitro senza pallina
Fox 40 CMG nero o colorato
con imboccatura anatomica
FOX 40 CMG Whistle
cushioned mouth grip



Art. 078M
Fischio Fox 40 Micro
nero o colorato (fino ad
esaurimento scorte)
Whistle FOX 40 Micro
black or coloured (until
available in stock)

pg.17



Art. 078SK
Fischio Fox 40 Sonik
nero, rosso o giallo
raggiunge 125 decibel
Whistle FOX 40 Sonik
black, red or yellow
reaches 125 decibel



Art. 078CH

Fischio senza pallina nero o colorato con cordoncino in confezione blister
Plastic whistle without a ball various colors with cord

Art. 228C
Fischio plastica
nero con cordoncino
Plastic whistle with cord



Art. 228
Fischio plastica nero
senza cordoncino
Plastic black whistle without cord



Art. 079C
Fischio cromato
con cordoncino
Chromed brass
whistle with cord



Art. 080
Cordoncino Lanyard
colore nero
nylon
whistle cords Lanyard
black color

pg.17



Art. F40CAP
Cordoncino Fox antipanico
regolabile, vari colori
Fox whistle cord adjustable
various colors



Art. 9816
Polsino regolabile
per fischietto Arbitro
Adjustable wristband
for referee's whistle



Art. 081 Coppia cartellini
con custodia e matita
Yellow and red cards
with holder and pen

pg.18



Lato A
Side A



Lato B
Side B

Art. 081F Coppia cartellini con
custodia, matita e tabellino gara
Yellow and red cards with holder,
pen and game note card



Art. RYC02
Set 1 cartellino arbitro
giallo e 1 rosso
Set 1 yellow and 1 red card
for referee



Art. 880147
Moneta per arbitro
in plastica
rosso/nera
referee's coin



Art. E3525
Custodia documenti
cm.13x8,6 (disponibile sino
ad esaurimento scorte)
Document Keeper

COMPRESSORI POMPE MANOMETRI CRONOMETRI - Inflators Pumps Gauges Chronos



Art. 106
Compressore
elettrico 220 Volt
con borsa
Electric Inflator
220 Volt
with bag



Art. 107
Manometro misura pressione palloni con valvola
(con indicazione pressioni consigliate per i vari sport)
Pressure Gauge with valve
(with indication of pressure for different sport balls)



Art. US107
Manometro misura pressione palloni alta precisione
con valvola (con indicazione
pressioni consigliate per i vari sport)
Pressure Gauge with valve high precision
(with indication of pressure for different sport balls)



Art. 104-A Pompa con ago - Pump with needle

pg.18

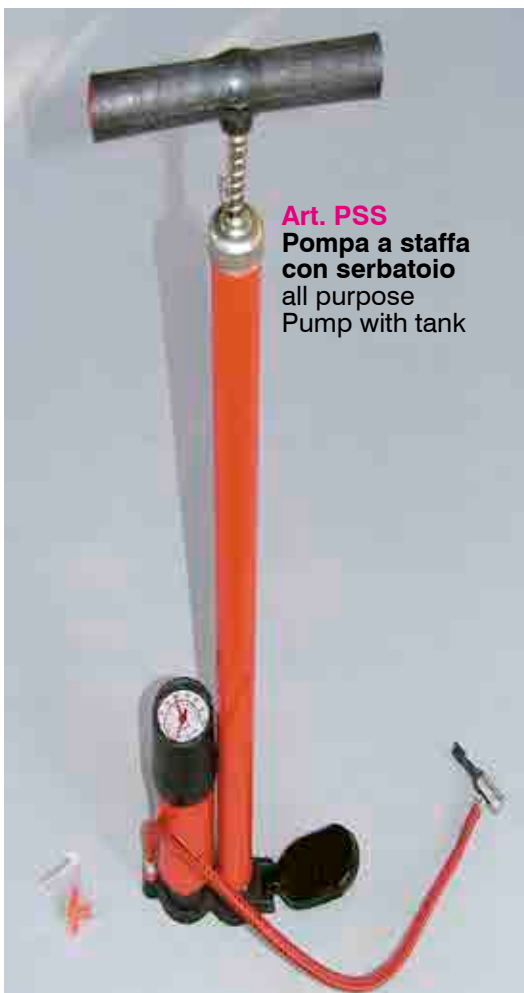

Art. PSS
Pompa a staffa
con serbatoio
all purpose
Pump with tank



Art. 2005
Confezione 12 Aghi
con valvola
per gonfiaggio
Set 12 Needles
with valve
for inflating balls



Art. 104-T
Pompetta in gomma soft
con ago e valvola di sfiato
ideale per gonfiaggio
palloni in gomma
Soft Pump with needle
and valve
for inflating rubber balls



Art. E73000
Cronometro digitale
 1/100 sec.
 certificato RoHS
 con visualizzazione di ora,
 calendario, sveglia,
 avvisatore sonoro
 Digital Chronometer 1/100 sec.
 displays hour, calendar, timer

New!

Art. CRN.E
Cronometro digitale
 1/100 sec
 Digital Chronometer
 1/100 sec.



Art. CR032
Cronometro al quarzo a 30
memorie
 Quartz Chronometer
 30 memories

pg.18

New!



Art. CMT Contametri fino a m. 9999
 Meter Counter (until m. 9999)

Art. PR10 Rotella Metrica in fibra m. 10
 Fiber measuring tape 10 m.



Art. CR031
Cronometro al quarzo a 100
memorie resistente all'acqua
 Quartz Chronometer
 100 memories - water resistant

New!



Art. PR20
Rotella Metrica
in fibra m. 20
 Fiber measuring tape 20 m.

Art. PR50
Rotella Metrica
in fibra m. 50
 Fiber
 measuring tape
 50 m.

Art. PR100
Rotella Metrica
in fibra m. 100
 Fiber measuring tape 100 m.

Lato A
Side A



Lato B
Side B



Art. C00937
Segnalatore bifacciale per cambio giocatori manuale fluorescente - base in plastica lucida
Substitution indicator fluorescent 1 piece 2 sides



Art. 072
Serie numeri cambio giocatori (da 1 a 25) con manico
Numbers for substitution (from 1 to 25) with handle



Lato A
Side A

Art. L199C
Segnalatore bifacciale economico per cambio giocatori manuale fluorescente con base in legno modello artigianale
Substitution indicator fluorescent 1 piece 2 sides with wooden base - cheap model

● pg.18

Lato B
Side B



Art. 071 Serie numeri cambio giocatori (da 1 a 25) senza manico
Numbers for substitution (from 1 to 25) without handle



Art. 072-D
Doppia serie (rossa e verde) di numeri da 1 a 99 per sostituzione giocatori - con manico
Double set of numbers (red and green) from 1 to 99 for substitution, with handle

TAVOLETTE ELETTRONICHE PER SOSTITUZIONI Electronic Substitution Boards



Art. FINOUT4

Tavoletta elettronica bicolore, monofacciale a 4 cifre (2+2) - led verdi per giocatore entrante led rossi per giocatore uscente, completa di caricabatteria - dim. cm. 55x36x4 kg. 2,75

4 Digit Electronic Substitution Board

1 side 2 color leds (red and green) cm.55x36x4 Kg. 2,75 with battery charger

Art. FINOUT8

Tavoletta elettronica bicolore, bifacciale a 4 cifre (2+2) - led verdi per giocatore entrante led rossi per giocatore uscente, completa di caricabatteria - dim. cm. 55x36x4 kg. 3,25

4 Digit Electronic Substitution Board

2 sides 2 color leds (red and green) cm.55x36x4 Kg.3,25 with battery charger



pg.18

Art. F290-20

Valigetta cm. 60x40x13,5 per Art. FINOUT4 e FINOUT8
Case 60x40x13,5 cm. for Art. FINOUT4 and FINOUT8



pg.18

UEFA
APPROVED
PRODUCTS



Art. 065-N

Tavoletta Elettronica Sostituzioni Delta F2002 approvata UEFA monofacciale, led monocolori rossi, completa di valigetta e caricabatteria
cm. 48x38,5x2 kg. 1,8

UEFA Electronic substitution Board 1 side
1 color red leds - bag and battery charger included

Art. 066

Tavoletta Elettronica Sostituzioni Delta FDI approvata UEFA bifacciale, led monocolori rossi, completa di valigetta e caricabatteria
cm. 48x38x4 kg. 3

UEFA Electronic substitution Board 2 sides
1 color red leds - bag and battery charger included

Art. 065-F

Tavoletta Elettronica approvata UEFA/FIFA bifacciale, bicolore a 4 cifre Delta 2F - completa di valigetta e caricabatteria - led rossi e verdi - ufficiale Mondiali Sudafrica 2010 - cm. 64,5x39x2,5 kg. 3

4 digit UEFA/FIFA Electronic substitution Board
2 sides - 2 color leds (red and green)
bag and battery charger included
(2010 FIFA World Cup South Africa)



SEGNAPUNTI - Scoreboards



Art. F160

Tabellone portatile multisport da tavolo con tastiera di comando per Basket, Volley, Calciotto, Pallanuoto, Pallamano, Kick Boxing, Ping-Pong etc. punteggi da 0 a 199 per lato set/bonus/falli da 0 a 9 per lato cronometro massimo 99 minuti e 59 secondi periodi da 0 a 9 - altezza cifre cm.9 dim. cm. 55x35x9,5

Multisport Table Scoreboard (for Basket, Volley, Futsal, Water Polo, Handball, Kick Boxing, Table Tennis)

pg.19



Art. F331

Cronometro da interno (minuti + secondi) dim. cm.85x38x11 - h. cifre 20 cm. con console

Timer for indoor with console

Art. F331T

Cronometro da interno (minuti + secondi) dim. cm.85x38x11 con telecomando a infrarossi

Timer for indoor with remote control



Art. B01084

Segnapunti per calciotto (basket, volley) da tavolo Table scoreboard for futsal (basket, volley)



Art. F300-14

Cronometro da esterno (minuti + secondi) dim. cm.166,5x59x15 - h. cifre cm. 45 con console Timer for outdoor with console

New!



Art. F300-26

Tabellone elettronico da esterno ideale per calcio, calcio ridotto e calciotto dim. cm.166,5x118x15 - altezza cifre 45 cm. Punteggio squadre da 0 a 9 - Cronometro 99:59 orologio - resistente agli urti della palla Electronic scoreboard for outdoor - ideal for Soccer, Futsal - resistant to ball hits

PALLONI CALCIO KWB - KWB Soccer Balls



Art. KWB.3 / KWB.4 / KWB.5
Pallone KWB official n.3, n.4 e n.5 in PVC
Ball KWB official size 3, 4 and 5 in PVC

Art. E6848
Pallone calcio KWB Gara in PU n. 5
KWB Soccer Ball in PU size 5

pg.19

PALLONI CALCIO E CALCETTO GEMS - GEMS Soccer and Futsal Balls



Art. GPA4
Pallone calcio Gems Olimpico
da allenamento in PU n. 4
Ball Gems in PU size 4



Art. GPA5
Pallone calcio Gems Olimpico
da allenamento in PU n. 5
Ball Gems in PU size 5



***Art. GPG4**
Pallone calcio Gems Azteca
da gara in TPU-PU n. 4
Ball Gems in TPU-PU size 4



***Art. GPG5**
Pallone calcio Gems Azteca
da gara in TPU-PU n. 5
Ball Gems in TPU-PU size 5



Art. GPSF
Pallone calcio Gems Sfera
da gara in PU-BIK/2Y 2,7 mm. - n. 5
Match Ball Gems size 5

New!

***Fino ad esaurimento scorte**
Until available in stock



Art. GMB2
Miniball Gems Italia
in pelle sintetica n. 2
Miniball Gems in pvc size 2



Art. GPC4
Pallone calcetto Gems Cuba
a rimbalzo controllato in PU n. 4
Futsal Ball Gems in PU size 4

PALLONI CALCIO E CALCETTO MOLTEN - MOLTEN Soccer and Futsal Balls



Art. FX801
Pallone calcio da allenamento Molten misto Pvc-Pu n.4
Molten training ball pvc/pu size 4



Art. FX800
Pallone calcio da allenamento Molten misto Pvc-Pu n.5
Molten training ball pvc/pu size 5

pg.19



Art. M1001.4
Pallone calcio Molten n.4 VG-1001-TR-LND per gare ufficiali categorie giovanili
Molten Soccer Ball VG-1001-TR-LND size 4



Art. M1000.5
Pallone calcio Molten n.5 VG-1000-TR-LND per allenamento professionisti e gare ufficiali categorie inferiori
Molten Soccer Ball VG-1000-TR-LND size 5



Art. VG1000A
Pallone calcio Molten n.5 VG-1000A-LND FIFA approved
Molten Soccer Ball VG-1000A-LND size 5

Art. M390P
Pallone calcetto Molten modello Mordax rimbalzo controllato
Molten Futsal Ball Mordax



Art. MTHO
Pallone calcetto Molten modello Thorax rimbalzo controllato (pallone ufficiale Calcio a 5 italiano)
Molten Futsal Ball Thorax

pg.20



pg.19

Art. MC170
Pallone Molten per calcio a 7 e a 8 misura 4,5 gr.360-400 PU opaco brillante
Molten Soccer Ball size 4,5

PALLONI CALCETTO E DA PALLEGGIO - Futsal and rubber balls



Art. OS123
Pallone calcetto rimbalzo controllato in pelle sintetica
Sala Ball controlled rebound in synthetic leather

Art. F100B
Pallone calcetto AGLA Bola F100 rimbalzo controllato in pelle sintetica
Sala Ball AGLA Bola F100 controlled rebound in synthetic leather



pg.19



Art. ULT46-3
Pallone calcetto gomma TRIAL triplo strato rimbalzo controllato gr.380 diam.cm.19,9
Slow Rebound Trial rubber Ball for Futsal

pg.20

Art. 26854
Pallone calcetto pelo lungo
Indoor Sala Ball



Art. 1935S
Pallone calcio in gomma misura n. 3 monostrato colori giallo, rosso e bianco
Barret Rubber soccer Ball size 3 single stratum colors: yellow, red and white

pg.20



Art. 8805S
Pallone calcio in gomma misura n. 5 monostrato (sino ad esaurimento)
Rubber soccer Ball size 5 single stratum



Art. 9965S
Pallone calcio in gomma misura n. 4 monostrato
Rubber soccer Ball size 4 single stratum



Art. 1945S
Pallone calcio in gomma misura n. 2 monostrato
Rubber soccer Ball size 2 single stratum



Art. V45/V44/V42/V41/V40
Palloni calcio in gomma Trial mono strato n. 1 - 2 - 3 - 4 - 5
Rubber soccer Balls single stratum Trial size 1 - 2 - 3 - 4 - 5



**Art. ULT42-3/ULT41-3/
ULT40-3**
**Palloni calcio in gomma
Trial triplo strato
n. 3 - 4 - 5**
Rubber soccer Balls
triple stratum Trial
size 3 - 4 - 5

pg.20



**Art. ULTST3/ULTST4/
ULTST5**
**Palloni Trial SILVER
STREET n. 3 - 4 - 5**
doppio strato
SILVER STREET Trial balls
size 3-4-5 double stratum



Art. TRILO
Pallone calcio Trial TRILO 4.5
**limita il trauma dovuto
all'impatto con la palla**
doppio strato
Soccer Ball Trial TRILO size 4.5
softens ball contact double stratum



Art. 149S14
Pallone piuma spugna Ø cm. 14
Foam rubber ball Ø 14 cm.



Art. 149S
Pallone piuma spugna Ø cm. 20
Foam rubber ball Ø 20 cm.



Art. M600

Pallone Molten in cuoio sintetico gr.600
Molten Training Ball
in synthetic leather 600 gr.



Art. ULTS40

Pallone in gomma Trial allenamento potenziato doppio strato
Ø cm.21,5 gr.630 (+50%)
Trial heavy rubber ball double stratum



Art. ULTD40

Pallone in gomma Trial allenamento potenziato doppio strato
Ø cm.21,5 gr.840 (+100%)
Trial heavy rubber ball double stratum

pg.21



Art. V43

Pallone "grullo" mono strato per allenamento portieri rimbalzo irregolare
Crazy Goal-Keeper Ball
single stratum irregular rebounds



Art. TRBC

Pallone reaction ball Trial doppio strato rimbalzo e traiettorie imprevedibili per calcio
Trial Reaction Ball unpredictable rebounds for soccer double stratum



Art. PLD5

Pallone Molten "grullo" allenamento portieri rimbalzo irregolare in pelle sintetica
Molten Crazy Goal-Keeper Ball
irregular rebounds in synthetic leather



Art. BYCC

Pallone Calcio bicolore gomma Trial Ø cm.21,5 gr. 420
Trial rubber bicolor ball

Favorisce la visualizzazione del senso di rotazione della palla permettendo il perfezionamento del gesto tecnico
Trial rubber bicolor ball:
It shows ball rotation allowing spin kick training

pg.21



Art. E48

Pallone sonoro Trial per non vedenti
Ø cm.22 - gr.470
Trial rattle ball for blind people



Art. B55 / B75

Relax Ball diametro cm. 5,5 / 7,5

PALLE MEDICHE a massa fissa o oscillante - Classic and Dynamic Medicine Balls



Art. 048 / 050 / 051 / 052 / 053
Palle Mediche rigonfiabili e rimbalzanti Trial
kg. 1 - 2 - 3 - 4 - 5
(il colore varia a seconda del peso)
Trial Medicine Balls
inflatable and rebounding
different colors for different
weights



Art. WMD100 / WMD200 / WMD300
Palle Mediche morbide Bubble Trial kg. 1 - 2 - 3
Soft Trial Medicine Bubble Balls kg. 1 - 2 - 3

Art. 048N / 050N
051N / 052N / 053N
Palle mediche rigonfiabili e rimbalzanti Trial
Kg. 1 - 2 - 3 - 4 - 5
colore grigio scuro
Trial Medicine Balls
in grey color

pg.21



Art. OV500 / OV1 / OV2 / OV3 / OV4 / OV5
Over ball Trial kg.0,5 - 1 - 2 - 3 - 4 - 5 con impugnatura anatomica
Over ball TRIAL

New!

Art. POL1/.../POL3.5
POLIBOLO - Over ball Trial a massa oscillante (riempite con acqua distillata)
peso kg.1 - 1,5 - 2 - 3 - 3,5
POLIBOLO TRIAL - Over ball filled with distilled water
weights 1 - 1,5 - 2 - 3 - 3,5 Kg.

Le Over ball e le Polibolo possono essere utilizzate sia come manubri sia come palle mediche
Over Balls and Polibolos can be used both as dumb bells and medicine balls



pg.21

New!

**DYNA05/DYNA1/ DYNA2/ DYNA3/
DYNA4/ DYNA5**

Palle mediche dinamiche con massa oscillante interna peso kg. 0,5-1-2-3-4-5
Dynamic medicine balls with liquid inside - weight 0,5-1-2-3-4-5 Kg.

Grazie a queste nuove palle mediche gli atleti utilizzano carichi non inerti ma dinamici, effettuando esercizi di forza coordinata nuovi e destabilizzanti. La massa oscillante (soluzione fisiologica) all'interno della palla medica dinamica impone, sia in fase di lancio che di carico, adattamenti muscolari e coordinativi istantanei la cui intensità è variabile, e quindi non prevedibile. Inoltre, per i più giovani le palle mediche dinamiche sono molto efficaci per la memorizzazione della tecnica e per migliorare la conoscenza ed il controllo del proprio corpo. È possibile gonfiare e sgonfiare tutte le Dyna variandone così la sofficietà ed il rimbalzo.

The new dynamic medicine balls allow new exercises for muscle strength, equilibrium and coordination.

The liquid inside these balls makes them dynamic weights that require new rapid and adapting movements both when throwing and when lifting. Younger players will also improve and memorize body movements enhancing their equilibrium. These balls can be inflated or deflated so that softness and rebound will change

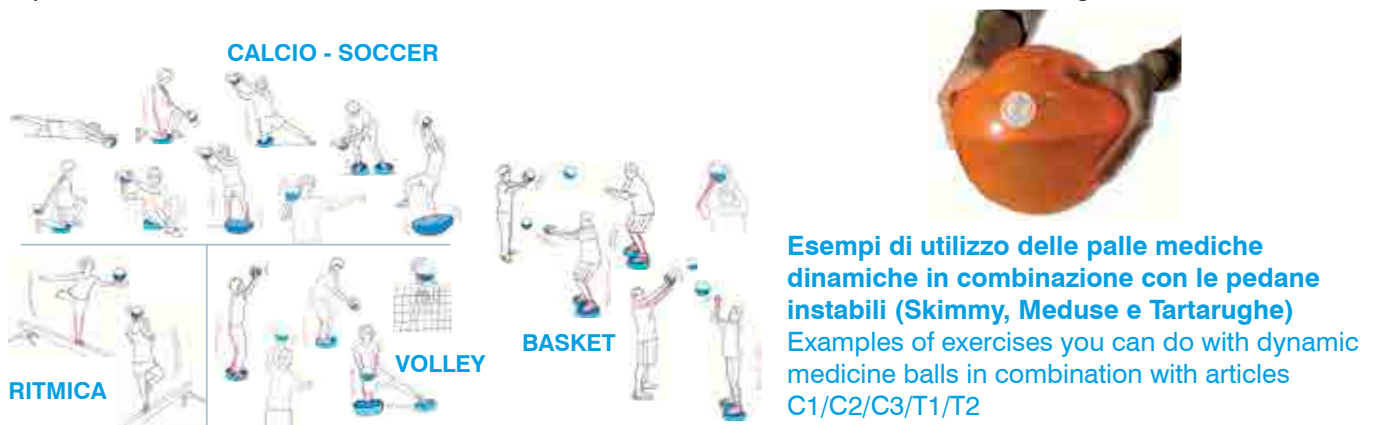

CALCIO - SOCCER



RITMICA



VOLLEY



BASKET

Esempi di utilizzo delle palle mediche dinamiche in combinazione con le pedane instabili (Skimmy, Meduse e Tartarughe)
Examples of exercises you can do with dynamic medicine balls in combination with articles C1/C2/C3/T1/T2

Art. KEB4/KEB8/KEB12/KEB16/KEB20
Kettlebell kg. 4 - 8 - 12 - 16 - 20



pg.11

PALLE RITMICHE E PSICOMOTORIE - Rhythmic and Gym Balls



pg.20

Art. 518S/516S/510S - Palle Ritmiche Mondo - Rhythmic Balls - gr. 400-240-160



Art. 42R/44R/46R/48R - Palle Ritmiche Trial - Rhythmic Balls - gr. 420-320-240-150



**Ideali per trattamento
fisioterapico,
equilibrio, stretching,
tonificazione, attività
aerobica, scarico
vertebrale,
riscaldamento,
potenziamento
muscolare ...**
Very useful for injury
recovery, equilibrium,
stretching, muscle
training, aerobic activity,
warm up ...



Art. 30934/30935/30936/31036

Palle psicomotorie monostrato

Gym balls single stratum various colors

Ø cm. 55

Ø cm. 65

Ø cm. 75

Ø cm. 85

pg.22



**Art. V10/V11/V12/V13/V14/V15/
V16/V17/V18/V19**

**Palle psicomotorie Trial in
gomma doppio strato
(il colore varia
a seconda del diametro)**

Trial Gym balls
in double stratum rubber

Ø cm.14-18-22-30

42-53-65-90-120-150

Art. V-LAB

**Palla psicomotoria Trial La Ball
con range di possibile utilizzo
da cm.50 a cm.70**

**struttura instabile in gomma doppio
strato particolarmente elastica**

Gym ball TRIAL La Ball

inflatable from 50 to 70 cm.

changing shape concept in very elastic
double stratum rubber



Palloni Linea Sun: Ø cm. 26 peso gr. 320 Ø 26 cm. weight 320 grams

Il diametro maggiorato favorisce l'apprendimento del bambino - Bigger diameter for youngest training and fun



Art. AL01 Big Sun
Fase di volo più lenta
Slower in the air



Art. AL02 Foot Sun
Per stimolare il tatto del bambino
To stimulate children's touch



Art. AL03 Crazy Sun
Cambia direzione ad ogni rimbalzo
Irregular rebounds

pg.21



Art. ULTbbs3
Pallone Jumbo Trial a 3 strati
diam. cm.28 - gr.280
Jumbo Trial Ball triple stratum



Art. BTR1
Palla sensoriale Ø cm. 21 - gr. 420
Sensory Ball Ø cm.21 - gr. 420



Le Palle sensoriali rimbalzanti esaltano la tattilità e rappresentano anche uno strumento di automassaggio a pressione
To stimulate touch and also useful massage tools

pg.20



Art. BTR2
Palla sensoriale Ø cm.12 - gr. 180
Sensory Ball Ø cm.12 - gr. 180



Art. TLV16
Palle Trial morbide per allenamento della visibilità laterale Set di 6 Palle diametro cm. 16 gr. 110
Soft balls for lateral visibility training Set of 6 balls 16 cm. diameter - 110 gr.

Art. TLV21
Set di 6 Palle diametro cm. 21 gr. 160
Soft balls for lateral visibility training Set of 6 balls 21 cm. diameter - 160 gr.

pg.7

Allenando la visibilità laterale migliorano la percezione dello spazio, i movimenti e la sicurezza nella vita quotidiana
For space perception, coordination and everyday life safety

BORSE - Bags

COLORI DISPONIBILI:
 rosso, royal, navy, nero,
 verde, amaranto
 Colors: red-royal-black
 green-navy-amaranthine

Art. TOM
 Borsa Grande cm 53x32x45
 poliestere 600
 Soccer bag large



Art. TON
 Borsa Media
 cm 50x30x42
 poliestere 600
 Soccer bag
 medium

New!



Art. E
 Zainetto doppio fondo poliestere 600
 3 tasche - cm.35x23x45 fondo rigido
 colori : royal, nero, rosso,
 navy, verde, bordeaux



Art. TOO
 Borsa Scuola Calcio
 cm 48x26x48 poliestere 600
 Soccer bag small

pg.22

Art. ZMAS
 Zainetto tricolore
 cm. 35x23x47
 con fondo rigido
 4 tasche poliestere 600
 in 22 combinazioni di colori
 Rucksack in 22 different colors



Art. PRE - Borsa Premier tricolore in poliestere 600
 con fondo rigido h. 15 cm. con tracolla e porta nome, tre tasche,
 dim. cm. 53x32x50 in 22 combinazioni di colori
 Soccer Bag Premier in polyester 600 3 pockets size 53x32x50 cm.
 in 22 different combinations of colors

Art. TOPS Porta scarpe poliestere 600
 in 22 combinazioni di colori
 Shoe Holder in 22 different colors



pg.23

Art. TOTPD
 Tracolla
 portadocumenti
 in 22 combinazioni
 di colori
 Documents Holder
 in 22 different colors



Art. TOBPL
Borsa palestra poliestere 600 cm. 50x30x28
colore nero, navy, rosso, royal
con tracolla imbottita, lastra rigida sul fondo, 3 tasche
Gym Bag colors black/blue/red/royal



Art. ZBGL
BORSA/ZAINETTO monocolore economica
serigrafabile su richiesta - vari colori
Backpack/Bag 1 color
with logo on request

New!



Art. TOBPM
Borsa Portamute cm.80x40x40
colore navy o nero nylon 420
Soccer bag for uniforms dim. 80x40x40 cm
color: black or navy

pg.23



Art. TOTRO
Trolley
professional in
rip-stop 600 2 tasche, tracolla,
porta nome, fondo rigido rivestito
dim. cm.62x34x52
colore navy, nero, royal,
rosso e verde
Trolley various colors



Art. TBMD
Borsa Medica dim. cm. 48x18x32
poliestere 600
Bag for First Aid 48x18x32



Art. BMD
Borsa Medica Bag for First Aid

CESTE PORTAPALLONI - Baskets for balls



Art. FP400
Cesta portapalloni in alluminio
pieghevole con sacca
Basket for balls in aluminum, foldable with bag



Art. F401
Cesta Portapalloni in ferro verniciato cm. 80 x 55 x 60h pieghevole
Basket for Balls in painted steel 80 x 55 x 60h cm. foldable



Art. F402
Cesta Portapalloni
in ferro zincato cm. 60 x 60 x 90h
pieghevole
Basket for Balls
in galvanized steel 60 x 60 x 90h cm.
foldable

pg.22

Art. F403G Cesta Portapalloni
in ferro verniciato cm. 100 x 75 x 90h.
pieghevole con lucchetto
Basket for Balls in painted steel
100 x 75 x 90h cm. foldable, with lock

Art. F404 Cesta
Portapalloni
in rete metallica
verniciata
dim. cm. 70x70x70
pieghevole
con lucchetto
Basket for Balls painted
with metallic net
70x70x70 h cm.
foldable, with lock



Art. F403ZN
Cesta Portapalloni in ferro zincato
cm. 100 x 75 x 90h.
pieghevole con lucchetto
Basket for Balls in galvanized steel
100 x 75 x 90h cm. foldable, with lock



Art. NCPR
Cesta portapalloni in nylon
con maniglie, tracolla e ruote
Bag for balls with handles and wheels



PORTE CALCIO - Soccer Goals



Art. 109
Coppia Porte fisse regolamentari in lega leggera costruite secondo gli standard Europei di Qualità UNI EN 748 con paletti tendirete posteriori in acciaio, pali sezione mm. 120x100 verniciati con smalto acrilico non tossico, ganci reggi rete e bossole per interrimento pali incluse (telaio posteriore di appoggio a terra non incluso)
Pair of regular Goals in light alloy manufactured according to the UNI EN 748 European standard of quality norms.
Pipe section 120x100 mm. painted with non toxic white.
Net holders, rear posts and underground bases included (ground backframes not included)

Art. 109.G
Coppia ribaltine posteriori alzarete per porte Art. 109 e S109
Pair of liftable ground backframes for Goals Art. 109 and S109 (to keep nets down to the ground and also to raise them up when cutting grass)

Art. SPP45
Set 4 protezioni imbottite h. cm. 200 per paletti posteriori tendirete
Set of 4 soft protections 200 cm. height for net holder posts

Art. SPR45
Set protezioni imbottite per coppia ribaltine alzarete
Set of soft protections for pair of ground backframes

New!

pg.23



Art. S109
Coppia Porte fisse regolamentari in lega leggera con paletti tendirete posteriori in acciaio galvanizzato, pali sezione mm. 120x100 verniciati con smalto acrilico non tossico, ganci reggi rete a vite e bossole per interrimento pali inclusi (telaio posteriore di appoggio a terra non incluso)
Pair of regular Goals in light alloy. Pipe section 120x100 mm. painted with non toxic white.
Net holders w/screws rear posts and underground bases included (ground backframes not included)

New!

New!



Art. 353.G
Serie 100 ganci reggi rete di ricambio modello a rotazione per porte regolamentari o ridotte
100 spare Net Holders rotating model for regular and reduced goals

pg.25

Attenzione:
verificare la tipologia dei ganci delle Vs. porte
prima di ordinare i ricambi
Please check the model of your holders before ordering spares



Art. 353
Serie 100 ganci reggi rete di ricambio modello con vite per porte regolamentari o ridotte
100 spare Net Holders with screws for regular and reduced goals

pg.25

In caso di ordine errato da parte del Cliente le porte, una volta consegnate, non possono essere sostituite



pg.23

Art. 110-BA Coppia Porte
Trasportabili in lega leggera
dimensioni regolamentari
profilo sezione mm. 120x100
base di appoggio posteriore
con profilo in lega mm. 120x100
complete di una coppia di reti
e di 8 ruote per il trasporto
 Pair of transportable Goals in light alloy regular size, pipe section mm. 120x100 back frame pipe 120x100 mm. complete with one pair of nets and 8 wheels for transport



Ruota in posizione di riposo
 Wheel in stand by position



Ruota in posizione di trasporto
 Wheel in transport position

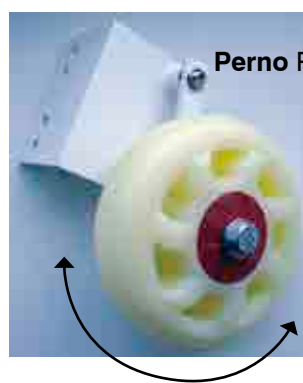

Perno Pivot

Ciascuna ruota in dotazione ha una posizione di riposo e una posizione di trasporto (per passare dall'una all'altra occorre far ruotare il dispositivo intorno al perno). Quindi, le ruote restano sempre fissate al telaio posteriore della porta
 Each wheel remains fixed to the back ground frame also when goals are in use, in stand by position. To switch the wheel into transport position you have to turn it around the pivot



pg.24

Art. 110BAG
Serie 60 ganci reggi rete di ricambio (esclusivamente per porte Art. 110-BA)
 60 spare
 Net Holders
 (only for Art.110-BA)



Art. 110FG - Coppia Porte Trasportabili in lega leggera dimensioni regolamentari profilo sezione mm. 120x100 verniciate con smalto acrilico non tossico base di appoggio posteriore con tubo tondo in ferro - a norma UNI EN 748
Pair of transportable Goals in light alloy regular size, pipe section mm. 120x100 painted with non toxic white - back frame in round iron pipe - UNI EN 748 standard



Art. 120-RG
Coppia ruote per porte trasportabili regolamentari articolo 110FG, 110-D e 110G
Pair of wheels for regular size transportable goals art. 110FG, 110-D and 110G

pg.24



LE PORTE TRASPORTABILI IN FASE DI GIOCO DEVONO ESSERE ZAVORRATE SULLA BASE POSTERIORE O FISSATE A TERRA CON PICCHETTI PER MOTIVI DI SICUREZZA. LE RUOTE GOMMATE SONO OPTIONAL

Transportable goals must always be anchored to the ground by sacs of sand or metal pegs, for safety reasons. Wheels are optional

Art. 110-D
Coppia Porte Trasportabili dim. regolamentari in lega leggera profilo sezione mm. 120x100 - verniciate con smalto acrilico non tossico base di appoggio posteriore con profilo ovale in alluminio mm. 65x56 - a norma UNI EN 748
Pair of transportable Goals in light alloy regular size, pipe mm. 120x100 painted with non toxic white - back frame in aluminum oblong pipe 65x56 mm.



Art. AMCP

Carrello per il trasporto di porte (trasportabili) regolamentari e ridotte - brevettato
Patented trolley for moving official and junior size transportable goals

pg.25



Art. 110G - Coppia Porte Trasportabili in lega leggera dimensioni regolamentari profilo mm. 120x100 verniciate con smalto acrilico non tossico, base di appoggio posteriore con profilo in lega mm. 120x100 - a norma UNI EN 748 e FIGC
 Pair of transportable Goals in light alloy regular size, pipe mm. 120x100, painted with non toxic white - back frame pipe 120x100 mm. - UNI EN 748 and FIGC standard



pg.24

Art. 120-RG
 Coppia ruote per porte trasportabili regolamentari articolo 110FG, 110-D e 110G
 Pair of wheels for regular size transportable goals art. 110FG, 110-D and 110G



Art. 4580M
 Mollone per ancoraggio porte trasportabili regolamentari e ridotte su terreno naturale
 Spring for goal anchoring on natural grass



Art. AFC

Art. AFC
 Zavorra in alluminio per ancoraggio porte trasportabili regolamentari e ridotte
 Aluminium weighted pipes for goal anchoring

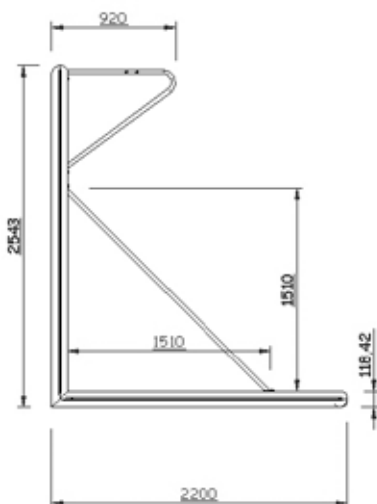

Art. DSS20 pg.25
 Sacco zavorra kg. 20 (riempito con sabbia) per ancoraggio porte trasportabili regolamentari e ridotte
 Ballast Bag weight 20 Kg. for goal anchoring

New!

Porte fisse o trasportabili in lega leggera o acciaio, sezione tubo mm. 120x100 - mm.80 - mm. 60 - dimensioni m. 3x2 - m. 4x2 - m. 5x2 - m. 6x2

Available fixed or transportable Goals - in light alloy or in painted steel, pipe section 120x100 mm. or 80 mm. or 60 mm. dimensions m. 3 x 2 - 4 x 2 - 5 x 2 - 6 x 2



Art. 118-G
Art. 114-T
Art. 116-TG
Art. 119 G
Art. 120 TG
Art. 120 G

Con distanziale a terra posteriore in tubo tondo
with round pipe ground base

Art. 118-G

Coppia Porte m. 4 x 2 - a traversa intera in lega di alluminio trasportabili tubo sezione 80 mm.
Pair of Goals m. 4 x 2 - 1 piece crossbar in light alloy, transportable, pipe 80 mm.

Art. 114-T

Coppia Porte m. 4 x 2 - a traversa intera in acciaio trasportabili tubo sezione 80 mm.
Pair of Goals m. 4 x 2 - 1 piece crossbar in painted steel, transportable, pipe 80 mm.

Art. 116-TG

Coppia Porte m. 5 x 2 - a traversa intera in lega di alluminio trasportabili tubo 80 mm.
Pair of Goals m. 5 x 2 - 1 piece crossbar in light alloy, transportable, pipe 80 mm.

Art. 1129A

Coppia Porte m. 5 x 2 - a traversa divisa in lega di alluminio trasportabili tubo 80 mm. con basi posteriori in profilo quadro
Pair of Goals m. 5 x 2 - crossbars in 2 pieces in light alloy, transportable, pipe 80 mm. with square pipe ground bases

pg.24

pg.25



Art. 118A
Art. 1129A
Art. 1121A

Base posteriore a sezione quadra reinforced ground base

Art. 118A

Coppia Porte m. 4 x 2 a traversa divisa in 2 pezzi in lega di alluminio trasportabili tubo 80 mm. con basi posteriori in profilo quadro
Pair of Goals m. 4 x 2 - crossbars in 2 pieces in light alloy, transportable, pipe 80 mm. with square pipe ground bases

Art. 119G

Coppia Porte m. 5 x 2 a traversa intera in acciaio trasportabili tubo 80 mm.
Pair of Goals m. 5 x 2 1 piece crossbar in painted steel, transportable, pipe 80 mm.

Art. 120-TG

Coppia Porte m. 6 x 2 - a traversa divisa in lega di alluminio trasportabili tubo sezione 80 mm.
Pair of Goals m. 6 x 2 - crossbars in 2 pieces in light alloy, transportable, pipe 80 mm.

Art. 1121A

Coppia Porte m. 6 x 2 - a traversa divisa in lega di alluminio trasportabili tubo 80 mm. con basi posteriori in profilo quadro
Pair of Goals m. 6 x 2 - crossbars in 2 pieces in light alloy, transportable, pipe 80 mm. with square pipe ground bases

Art. 120-G

Coppia Porte m. 6 x 2 - a traversa intera in acciaio trasportabili tubo sezione 80 mm.
Pair of Goals m. 6 x 2 crossbars in 2 pieces in painted steel, transportable pipe 80 mm.

LE PORTE TRASPORTABILI IN FASE DI GIOCO DEVONO ESSERE ZAVORRATE SULLA BASE POSTERIORE O FISSATE A TERRA CON PICCHETTI PER MOTIVI DI SICUREZZA. LE RUOTE GOMMATE SONO OPTIONAL

Transportable goals must always be anchored to the ground by sacs of sand or metal pegs, for safety reasons. Wheels are optional



Art. 120-R

Coppia ruote per porte trasportabili ridotte con base posteriore in profilo quadro
Pair of wheels for reduced size transportable goals with square pipe ground bases

pg.25



Art. 4640

Ruota per porte trasportabili ridotte tubo 80 mm. con distanziale in tubo tondo
Wheel for transportable goals reduced size pipe 80 mm. with round pipe ground bases



Le porte ridotte sono disponibili anche nel modello fisso con pali e bossole da interrare Available also fixed models with underground bases



Art. 121G
Coppia Porte Calcetto trasportabili
m. 3 x 2 in lega leggera tubo sezione 80 mm.
 Pair of Goals m. 3 x 2 transportable
 in light alloy pipe 80 mm.

Art. 122G
Coppia Porte Calcetto trasportabili
m. 3 x 2 in acciaio verniciato
tubo sezione 80 mm.
 Pair of Goals m. 3 x 2 transportable
 in painted steel pipe 80 mm.

LE PORTE TRASPORTABILI IN FASE DI GIOCO DEVONO ESSERE ZAVORRATE SULLA BASE POSTERIORE O FISSATE A TERRA CON PICCHETTI PER MOTIVI DI SICUREZZA.
 Transportable goals must always be anchored to the ground by sacs of sand or metal pegs, for safety reasons.



Art. DSS20
Sacco zavorra kg. 20
(riempito con sabbia)
per ancoraggio
porte trasportabili
regolamentari e ridotte
 Ballast Bag weight 20 Kg.
 for goal anchoring

pg.25

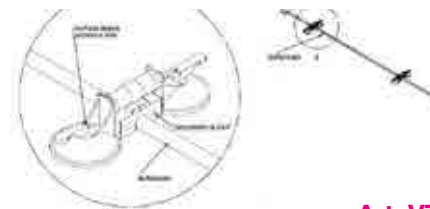

Art. VTCL
Coppia ventose per ancoraggio
a terra porte calcetto
su superfici indoor lisce
(si consiglia una coppia
di ventose per porta)
 Pair of ground anchoring
 for reduced goals to be used
 upon indoor smooth floors
 (It takes one pair for every goal)



Art. 122AV
Coppia Porte Calcetto
trasportabili
m. 3 x 2 in acciaio
tubo sezione 60 mm.
 Pair of Goals m. 3 x 2
 transportable
 in painted steel pipe 60
 mm.
con fascette trasparenti
fissa rete ai pali
 without net holders

Ideali per uso
privato
not for official
matches



Art. PC04
Picchetto in alluminio per ancoraggio
a terra porte con tubo sezione 60 o 80 mm.
con distanziale a terra in tubo tondo
 Aluminium anchoring Hook
 for reduced soccer goals pipe 60 or 80 mm.
 with round pipe ground bases

Art. AM01.7/.../AM01.3
TUBO ZAVORRA in Pvc diametro 50 mm. atossico,
flessibile, modellabile, appesantito da composto
ecologico (peso 6 Kg. per metro) resistente alle alte e
basse temperature e ai raggi ultravioletti
per porte ridotte mt. 3x2/4x2/5x2/6x2
e regolamentari sia fisse che trasportabili
 Weighted soft Pipe 50 mm. diameter
 (6 Kg. per meter) resistant to low
 temperatures and ultra violet rays
 for safe anchoring of transportable goals
 m. 3x2/4x2/5x2/6x2 and official size goals
 to the ground

pg.25





pg.25

Ideali per uso
privato
Not for official
matches

Art. SG176

Porta m. 3x2 trasportabile in ferro verniciato, tubo sezione mm. 32 completa di rete, ganci e picchetti

3x2 meter transportable Goal in painted iron, pipe section 32 mm. complete with net, hooks and pegs



pg.25



Art. TP1026 Coppia Porte m. 3x2 in alluminio rivestite con gomma soffice impermeabile anti-infortunistica - complete di reti

Pair of goals 3x2 m. in aluminium covered with soft non soakable safe rubber - nets included

PORTE BIFRONTALI in lega leggera o acciaio dimensioni m. 3x2 - 4x2 - 6x2

Available 2 SIDE GOALS in light alloy or in painted steel dimensions m. 3 x 2 - 4 x 2 - 6 x 2

pg.26



Art. 084

Porta bifrontale m. 4 x 2 in lega leggera, completa di rete sezione tubo 50 mm.
Two Side Goal 4 x 2 m. in light alloy pipe 50 mm. net included

Art. 084AC

Porta bifrontale m. 4 x 2 in acciaio verniciato tubo sezione 50 mm. completa di rete
Two Side Goal 4 x 2 m. in painted steel, pipe 50 mm. net included

MINI PORTE - Mini goals



pg.26



Art. 123 Coppia Miniporte professionali in acciaio m. 1,5 x 1 complete di reti
Pair of professional steel Mini-goals m. 1,5 x 1 nets included



Art. 124C
Coppia Miniporte m. 1,5 x 1,1 in Pvc rinforzato tubo Ø 70 mm. complete di reti
Pair of Pvc Mini-goals m. 1,5 x 1,1 pipe Ø 70 mm. nets included

pg.26



Art. 123C
Coppia Miniporte in acciaio verniciato m. 1,5 x 1 complete di reti e picchetti
Pair of Mini-goals m. 1,5 x 1 in painted steel
pegs and nets included



Art. 123F Coppia Miniporte in acciaio verniciato m. 1,5 x 1 complete di reti e picchetti
 Pair of Mini-goals m. 1,5 x 1 in painted steel pegs and nets included

pg.26

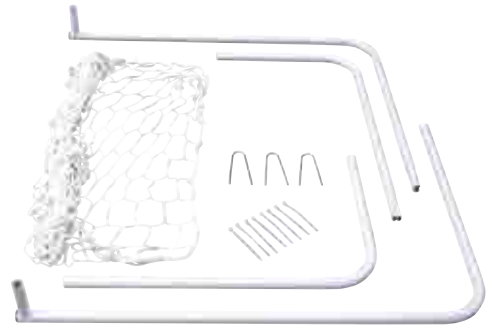

Art. P124 Coppia Miniporte in Pvc m. 1,5x1,1 tubo Ø 32 mm. complete di reti
 Pair of Pvc Mini-goals m. 1,5x1,1 pipe Ø 32 mm. nets included

Dimensioni
Porta ribaltata
m. 1,5 x 0,80
Goal upside
down dimensions
1,5x0,80 m.

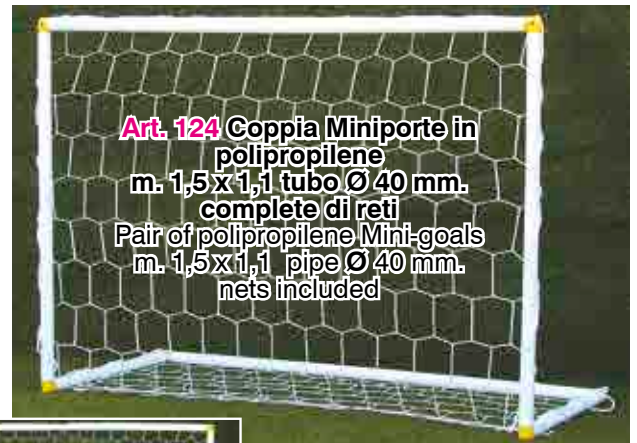

Art. 124 Coppia Miniporte in polipropilene m. 1,5x1,1 tubo Ø 40 mm. complete di reti
 Pair of polipropilene Mini-goals m. 1,5x1,1 pipe Ø 40 mm. nets included



Dimensioni Porta ribaltata
m. 1,5 x 0,80
Goal upside down
dimensions 1,5 x 0,80 m.

pg.26



Art. A124 Coppia Miniporte in alluminio m. 1,5 x 1,1 tubo Ø 32 mm. complete di reti
 Pair of aluminium Mini-goals m. 1,5 x 1,1 pipe Ø 32 mm. - nets included



Dimensioni Porta ribaltata m. 1,5 x 0,80
Goal upside down dimensions 1,5 x 0,80 m.

pg.26

Art. IS214 Miniporta in acciaio m. 2 x 1,4 completa di rete e telone bersaglio
 Steel Mini-goal m. 2 x 1,4 net and pvc target included



RETI REGOLAMENTARI - Regular Nets



***Le reti a maglia esagonale sono tessute, quelle a maglia quadrata sono annodate**

***Square mesh nets are knotted**



Art. 125E

polipropilene sp. mm. 3
profondità cm.170x170 depth

pg.26

pg.27



Art. 125

polipropilene sp. mm. 4
profondità cm.170x170 depth



Art. 126

poliestere sp. mm. 5
profondità cm.100x200 depth



Art. 127

polipropilene sp. mm. 5
profondità cm.200x200 depth



Art. B19

polietilene sp. mm. 3,5
profondità cm.100x200 depth



Art. 128E

polietilene sp. mm. 3,5
profondità cm.170x170 depth



Art. 128

polietilene sp. mm. 4,5
profondità cm.200x200 depth



Art. 128FR Coppia reti annodate in polietilene sp. mm. 4 bianche o a strisce colorate (bianco-royal, bianco-rosso, giallo-royal)

profondità cm.100x200 depth

Pair of nets polietilene 4 mm. color stripes, knotted (available in white, white-royal, yellow-royal, white-red)



Art. 128C Coppia reti annodate in polietilene sp. mm.3,5 a strisce colorate (bianco-royal, bianco-rosso, giallo-royal, rosso-blu, bianco-nero, bianco-verde)

profondità cm.200x200 depth

Pair of nets polietilene 3,5 mm. color stripes, knotted (available in white-royal, yellow-royal, white-red, white-black, white-green, red-blue)



Art. 129T

Coppia reti polipropilene sp. mm. 6 annodate a mano a strisce colorate (consigliabile per combinazioni di colori alternative a quelle degli Art. 128FR e 128C)

profondità cm.200x200 depth

Pair of nets with color stripes, hand knotted in various combinations

RETI RIDOTTE - Reduced Size Nets



Art. 131.5
Coppia Reti Pair of Nets
m. 6,50 x 2,50
Polipropilene sp. mm. 4

Art. 133
Coppia Reti Pair of Nets
m. 4 x 2
Polipropilene sp. mm. 4

Art. 133SN / 132N / 131N
Coppia Reti Pair of Nets
annodate
m. 4x2 - 5x2 - 6x2
knotted
polietilene sp. mm. 2,5



Art. B170 / B171
Coppia Reti Pair of Nets
annodate m. 6x2 - 5x2
knotted polietilene sp. mm. 3,5

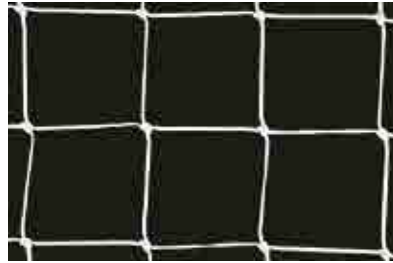

Art. 133LR / 133NP
Coppia Reti Pair of Nets
annodate m. 4x2
knotted polietilene sp. mm. 3,5
prof. cm.100x100/cm.100x160 depth

RETI CALCETTO - Futsal Nets m. 3x2



Art. 134E
polietilene
annodate knotted
sp. mm. 2,5



Art. 134 polipropilene
sp. mm. 4
Art. 134T polipropilene
sp. mm. 4 - **tricolori**

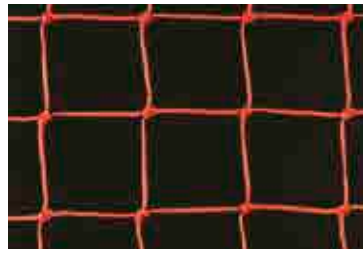

Art. 135
polietilene sp. mm. 4,5 **annodate** knotted
rosse, bianche o gialle
red, yellow or white

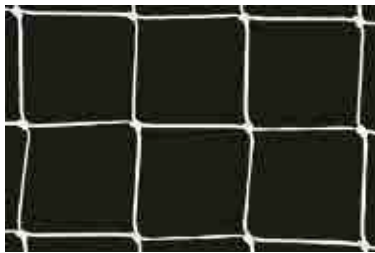
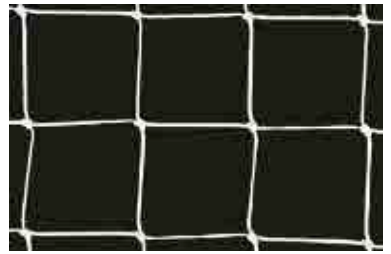

Art. 135C
polietilene **annodate** knotted
colore bianco sp. mm. 3,5
color white

pg.27



Art. 135FR
polietilene **annodate** knotted
colori: bianco-royal, bianco-rosso, giallo-royal sp. mm. 3
colors: royal/white, red/white, yellow/royal



pg.27



Art. GM Rete respingente con
sacche per tiri di precisione
completa di corda elastica
e picchetti (da applicare a porta
regolamentare)
Special nets with accuracy pockets
including elastic rope and pegs
for regular size goal

*Basta raccogliere palloni
in fondo al sacco, lascia che sia la palla
a tornare da te !
Stop picking up balls all the time,
let the ball come back to you !*

RETI DI PROTEZIONE - PROTECTION NETS



*** TUTTE LE RETI DI PROTEZIONE VENGONO REALIZZATE SU MISURA IN BASE ALLE RICHIESTE DEL CLIENTE in circa 10 giorni**

* All protection nets are manufactured according to Customer's needs in about 10 days time

pg.27

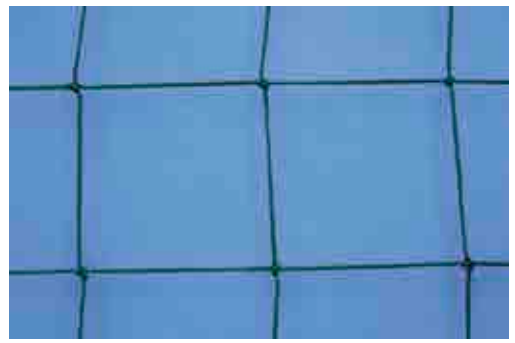

Art. 093N

Rete protezione polietilene verde annodata maglia cm. 13x13 sp. mm. 2,5 per calcio e calcetto

Protection Net green polyet. mesh 13x13 cm. knotted, thickness 2,5 mm.



Art. 093.5

Rete protezione polietilene verde cm. 13x13 annodata sp. mm. 3,5 per calcio e calcetto

Protection Net green polyetilene mesh 13x13 cm. knotted, thickness 3,5 mm.

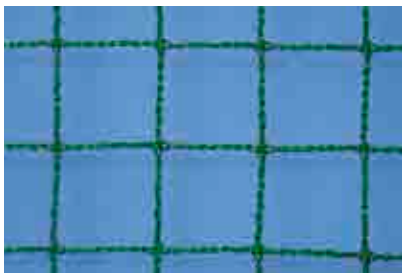

Art. 0934LR

Rete protezione polietilene verde maglia mm. 45x45 sp. mm. 2 (per tennis e baseball)
Protection perimetral Net for tennis and baseball

pg.28

Art. R55

Rete protezione polietilene nera maglia mm.18 annodata sp. mm.2 anti-oggetto anti-petardo
Protection Perimetral Net anti-objects and fire crackers

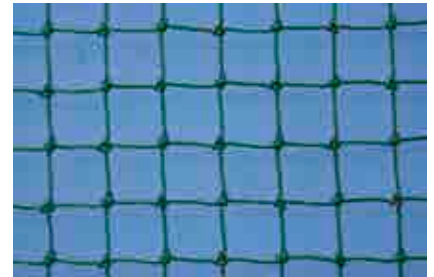
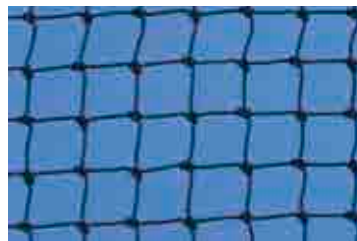

Art. R57

Rete protezione Polietil. verde maglia mm. 25x25 sp. mm. 3 (per golf)
Protection perimetral Net for Golf

RETI PORTA PALLONI - BALL SACS



Art. 041-6 / 041-12 / 041-18
Art. S041-6 / S041-12 / S041-18
Reti Portapalloni standard o annodate (da 6 / 12 / 18 pz.)
Nets for Balls standard or knotted (6 / 12 / 18 pc.)

pg.27

Art. SM20
Sacca Portapalloni in nylon/pvc 420 capienza 20 palloni
Ball Sac - for 20 balls



BEACH SOCCER

pg.26

**Art. PBST Coppia Porte beach soccer m.5,5x2,2
in lega d'alluminio - tubo sezione 80 mm.
verniciate di giallo**

Pair of beach soccer goals in aluminium
5,5x2,2 meters
pipe 80 mm - painted yellow



**Art. 110BS
Coppia Porte beach soccer m.5,5x2,2
in lega d'alluminio
tubo sezione 120x100 mm.
verniciate di giallo**

Pair of beach soccer goals in aluminium
5,5x2,2 meters
pipe 120x100 mm - painted yellow



**Art. 073BS
Kit 10 bandierine
complete
per beach soccer
6 rosse e 4 gialle
Beach Soccer
Kit of 10 Flags
6 red and 4 yellow**



**Art. RBS Coppia reti
per porte beach soccer mt.5,5x2,2
Pair of nets for beach soccer goals
5,5x2,2 meters**



**Art. KDBS
Kit delimitazione per campo Beach Soccer, colore
blu: 2 nastri m.28 + 2 nastri m.37 da mm. 80
+ 8 picchetti e 8 elastici
Kit for Beach Soccer bounds**



**Art. ISBS
Pallone Beach Soccer
in pelle sintetica
Beach Soccer Ball
in synthetic leather**



**Art. ULT45
Pallone Beach
Soccer Trial in gomma
doppio strato
Trial Beach Soccer Ball
double stratum rubber**

PANCHINE ALLENATORI - TRAINERS' DUG-OUTS



Altezza tettuccio cm. 200 profondità fianco laterale cm. 74
Roof height : 200 cm. - side depth : 74 cm.



Art. 155AV/156AV/157AV/158AV/159AV/159.8AV/155AV4

Panchina con struttura in tubo quadro in lega d'alluminio mm. 30x30 con copertura in policarbonato alveolare non trasparente - fianchi laterali in policarbonato trasparente (2 scocche di seduta in polipropilene per ogni metro di lunghezza)

Dug-out in light alloy square pipe mm. 30x30 with non transparent alveolar protection
Transparent protection on both sides (2 polypropylene seats per every meter of length)

pg.29

pg.30

*E' possibile sostituire le scocche con le panche a listoni in legno con schienale senza variazioni di prezzo
Available wooden benches with back in spite of seats, at the same price*



E' necessario fissare le panchine su una base in cemento tramite tasselli; la base dovrà essere più estesa di circa 30 cm. per ciascun lato rispetto alla lunghezza e alla profondità della panchina.

It is necessary to anchor dug-outs upon concrete base. Size of concrete base must be about 60 cm. longer and deeper than dug-out perimetral size (30 cm. longer and wider on each of the 4 sides)



Altezza tettuccio cm. 200 profondità fianco laterale cm. 74
 Roof height : 200 cm. - side depth : 74 cm.

Art. 155/156/157/158/159/159.8/155-4

Panchina con struttura in tubo quadro in lega d'alluminio mm. 30x30 con copertura in policarbonato trasparente e scocche di seduta in polipropilene (2 scocche di seduta per ogni metro di lunghezza)
 Dug-out in light alloy square pipe mm. 30x30 with transparent polycarbonate protection
 (2 polypropylene seats per every meter of length)

pg.29

La verniciatura con colore a richiesta del tubo quadro in alluminio comporta una maggiorazione del prezzo del 10%
Optional painting of the square pipe frame in aluminium (color on request): 10% additional charge on selling price

E' possibile sostituire le scocche con le panche a listoni in legno con schienale senza variazioni di prezzo
Available wooden benches with back in spite of seats, at the same price

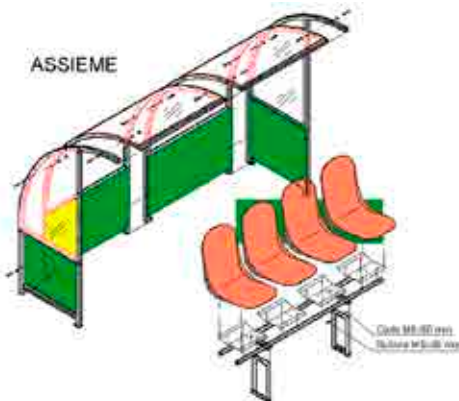

Art. ASBI
Scocca ricambio per panchina allenatori colore rosso o blu
 Spare Seat for Dug-Outs in red or blue color

pg.30

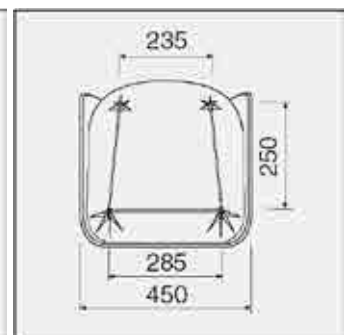
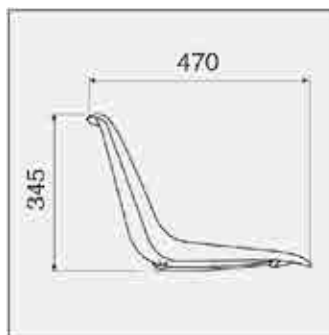

È necessario fissare le panchine su una base in cemento tramite tasselli: la base dovrà essere più estesa di circa 30 cm. per ciascun lato rispetto alla lunghezza e alla profondità della panchina
It is necessary to anchor dug-outs upon concrete base. Size of concrete base must be about 60 cm. longer and deeper than dug-out perimetral size (30 cm. longer and wider on each of the 4 sides)



**Panchina allenatori
profilo curvato
mm 50x30 in acciaio
zincato a caldo
Art. V6230 e seg.
rivestimento
posteriore in
policarbonato
alveolare non
trasparente spessore
mm 4, fianchi
rivestiti in
policarbonato
trasparente mm 3,
piano di seduta in
scocche di
polipropilene montate
su telaio zincato**

Altezza tettuccio cm. 200, profondità fianco laterale cm. 88

pg.29

**Panchina allenatori
profilo curvato
mm 50x30 in acciaio
zincato a caldo
Art. V6220 e seg.
rivestimento
posteriore e laterale in
policarbonato
trasparente spessore
mm 3, piano di seduta
in scocche di
polipropilene montate
su telaio zincato**



**Art. V6285
Protezione in poliuretano espanso
per bordo panchina allenatori
profilo mm. 50x30**

**Art. V6288
Coppia ruote da applicare a
panchina profilo 50x30 al fine
di renderla trasportabile**



PANCHINE LUSSO - LUXURY DUG-OUTS

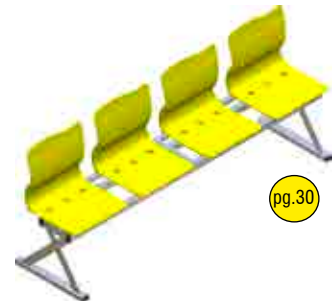

pg.30

Art. 155FZ2/155FZ4/155FZ6/155FZ8

Panchina allenatori in acciaio zincato a caldo rinforzato profilo mm. 40x40 con profondità cm.180 (misurando da tettuccio a limite base posteriore di appoggio)

Rivestita con lastre in policarbonato trasparente spessore mm. 3.

Piano di seduta in scocche in polipropilene Mondo Seat 6 oppure poltrone lusso personalizzabili

Dug-Out in galvanized steel pipe 40x40mm. - 180 cm. depth (from back protection to edge of roof)

Transparent polycarbonate 3mm. thick back cover - Polypropylene seats on steel frame (2 seats each meter) or leather luxury armchairs



Art.155FZ8 + 155PR + 12 x PLEX



Art. 155PR

Rivestimento di protezione in schiumato per tettuccio e montanti
Soft edge protections

Art. PLEX Leather bi-color armchair for Poltrona Plex-Stadio by Caloi con rivestimento in pelle bicolore (colori a scelta) piastra per fissaggio a terra (conteggiare 3 poltrone ogni 2 metri di panchina)



pg.30

Logo applicabile su richiesta



Art.155FZ8 + 155PR + 12 x PLEX

PANCHINE ALLENATORI IDEALI PER CAMPI CALCETTO TRAINERS' DUG-OUTS FOR FUTSAL PITCHES



Panchina allenatori profilo curvato
mm 40x20 in acciaio zincato a freddo
rivestimento posteriore e laterale
in polycarbonato alveolare sp. mm. 4
profondità a terra cm. 97,
altezza massima cm. 208
lunghezza metri 2 oppure metri 3
con panca sedute
in acciaio zincato e legno pg.30
Art. V6242.2 e Art. V6242.3
o con panca sedute pg.31
in alluminio anodizzato
(come raffigurato nelle immagini)
Art. V6241.2 e Art. V6241.3



Dug-Out curved profile
40x20 mm in galvanized steel cold finish
rear and side coverings
in non transparent polycarbonate
4 mm. thick
soil depth. 97 cm.
maximum height 208 cm.
2 meters or 3 meters length
with wooden bench on
galvanized steel
Art V6242.2 and V6242.3
or with bench in
anodized aluminium
(as shown in pictures)
Art V6241.2 and V6241.3

PANCHINE ALLENATORI IDEALI PER CAMPI CALCETTO TRAINERS' DUG-OUTS FOR FUTSAL PITCHES



● pg.31



Panchina allenatori trasportabile su ruote - profilo curvato mm 50x30 in lega di alluminio rivestimento posteriore e laterale in polycarbonato alveolare sp. mm. 4 Art. V6291 oppure in polycarbonato trasparente sp. mm. 3 Art. V6292 profondità a terra cm. 150, altezza utile cm. 210 lunghezza metri 3 con supporto sedute in acciaio zincato e 6 scocche in polipropilene con piano borse sul retro dei seggiolini

Dug-out transportable on wheels
curved profile 50x30 mm in light alloy
Rear and side coverings in non transparent polycarbonate mm. 4 thick
Art V6291 or in transparent polycarbonate mm. 3 thick **Art V6292**
depth on the ground 150 cm.
useful height 210 cm.
length 3 meters
with galvanized steel seat support
and 6 polypropylene seats
with back space for bags



PANCHINE LUSO TRASPORTABILI - LUXURY TRANSPORTABLE DUG-OUTS



Art. LXR2/LXR4/LXR6

**Panchina allenatori in tubo di acciaio zincato a caldo profilo mm. 40x40
TRASPORTABILE su ruote - Copertura in policarbonato trasparente profondità
cm. 180 - Piano di seduta in scocche in polipropilene Mondo Seat 6 oppure
poltrone lusso personalizzabili con colori e logo del club
Dug-Out in galvanized steel pipe 40x40 mm. - TRANSPORTABLE on wheels
transparent polycarbonate back cover
polypropylene seats or leather luxury armchairs
(luxury armchairs can be customized with club colors and club or sponsor logo)**

**Art. LXR2-LXR4-LXR6 MODELLI INDICATI QUANDO
SI NECESSITA DI PANCHINE LUNGHE E TRASPORTABILI**
Dug-out model to be chosen when you need lots of transportable seats



pg.30

New!





Art. 146

Vernice Ecologica atossica per manti erbosi Linea Stadio
lt. 15 - Kg. 19 ad alto rendimento
Ecological Paint for grass 15 liters - 19 Kg.



Art. 146E

Vernice Ecologica atossica per manti erbosi Biancostadio lt. 17 - Kg. 19
Ecological Paint for grass 17 liters - 19 Kg.



Art. 3MT

Rotolo Nastro adesivo mt. 50 - h. 5 cm.
vari colori per tracciatura righe su superfici sintetiche
Tape for bounds 50 meter - 5 cm. height

Art. 146BP
Vernice bianca o gialla per manti sintetici a bassa permanenza (1 settimana)
17 litri, da utilizzare preferibilmente con carrello a rulli
Paint for artificial grass white or yellow color, short durability (1 week) 17 liters



Art. 146LP
Vernice bianca o gialla per manti sintetici a lunga permanenza (3 mesi)
17 litri, da utilizzare solo con carrello a rulli
Paint for artificial grass white or yellow color, long durability (3 months) 17 liters

New!



Art. ELP2/ELP4

Elasticone per divisione spazi
h. cm. 2 oppure h. cm. 4
lunghezza mt. 20, completo di 2 moschettoni
Elastic bound 2 cm. height or 4 cm. height - length 20 meters - with 2 hooks

pg.28



Art. PFIx Plifix
Picchetto di riferimento permanente con erba sintetica bianca o colorata, per agevolare la tracciatura delle righe dei campi di gioco o per delimitazioni aree.
Confezione da 25 pezzi utensile in plastica incluso
Plifix - permanent peg with artificial white or colored grass to help tracing lines on the field or mark areas.
25 piece set includes also plastic planting device



pg.12



CARRELLI TRACCIALINEE - LINE MARKERS



Per una resa ottimale
e per evitare inconvenienti
utilizzare sempre carbonato di calcio,
cioè la comune polvere di marmo

Art. 142S

**Carrello traccia linee
a polvere**

Marble Powder Line Marker



pg.28

**UTILIZZARE SOLTANTO
VERNICE ECOLOGICA
ATOSSICA E RISCIAQUARE
DOPO OGNI USO IL
SERBATOIO E TUTTO IL
CIRCUITO DI SPRUZZO SINO
AGLI UGELLI**

**(occorre spruzzare
ripetutamente acqua prima di
riporre l'attrezzo)**

Always use ecological paint and
wash with water after use (put
water in the tank and spray)



Art. 144

**Carrello traccia linee
a vernice ecologica
con serbatoio munito di
pompano a pressione
manuale**

Paint Line Marker,
with manual pressure tank

**Nuove ruote
anti fango
in dotazione
new wheels
anti mud**



pg.28



Dettaglio
leva pressione
spruzzo

Art. 145

**Carrello traccia linee
a vernice ecologica**

**con motore a scoppio
a miscela**

serbatoio vernice lt.25

tracciatura laterale regolabile

Paint Line Marker

with 2 stroke engine

25 liter tank

Art. 144.EL
Carrello traccia linee a vernice elettrico completo di caricabatteria (per la batteria della pompa elettrica)
capacità serbatoio litri 18
tracciatura laterale regolabile
Electric Line Marker complete with battery charger
18 liter tank
adjustable lateral marking device

● pg.28



Art. 144.SL
Carrello traccia linee a rulli senza serbatoio a pressione né motore a scoppio. Tramite la rotazione dei rulli, la vernice viene prelevata all'interno del serbatoio e spalmata sull'erba.

Roller Paint Line Marker
Just fill up the tank with paint and push the machine.
Taking advantage of rolling wheels, paint flows from tank down to grass the easiest way!

TRIBUNE - STANDS



Art. G12005

Modulo Tribuna per interno/esterno su 3 file in acciaio zincato trasportabile su ruote, piani di seduta in carply, lunghezza m. 2,5
Indoor/outdoor Stand in galvanized steel, 3 rows, movable on wheels, with wooden benches



pg.31

pg.32

Art. G12006

Modulo Tribuna per interno/esterno su 3 file in acciaio zincato trasportabile su ruote, piani di seduta con scocche in polipropilene, lunghezza m. 2,5
Indoor/outdoor Stand in galvanized steel, 3 rows, movable on wheels, with polypropylene seats

Art. G120TM

Tribuna telescopica da interno con scocche in polipropilene M90
Telescopic Stand for indoor with M90 polypropylene seats





Art. 1200G
Tribuna fissa per interni in acciaio verniciato
piani di seduta con panchette
o con scocche in polipropilene M90
Indoor Stand in painted steel with wooden benches
or with M90 polypropylene seats

pg.31

pg.32



Art. PL1200 / PP1200 / PLZ120 / PPZ120
Parapetti laterali e posteriori
in acciaio verniciato o zincato
per tribune fisse da interno o esterno
Lateral and back protections in painted or
galvanized steel for indoor and outdoor stands

Art. 120NZG

Tribuna fissa per esterni in acciaio zincato
piani di seduta con panchette
o con scocche in polipropilene M90
Outdoor Stand in galvanized steel with wooden
benches or with M90 polypropylene seats



Art. S07682
Transenna in acciaio zincato
cm.200x100h.
Galvanized steel barrier

SCOCHE PER TRIBUNE - STADIUM SEATS

COLORI DISPONIBILI : blu, rosso, giallo, verde
AVAILABLE COLORS : blue, red, yellow, green

pg.31



Art. M2003

Art. M2003 Scocca in polipropilene ignifuga e antiultravioletti con schienale (secondo normativa Uefa) fissaggio diretto sulla gradinata con tasselli (non inclusi)
 Polypropylene Seat non ignitable and anti ultraviolet rays with back rest (according to UEFA requirements) to be fixed with screws (not included)

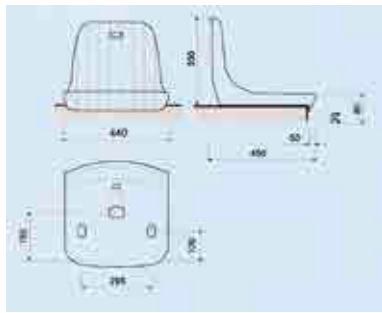

Art. M2003A Scocca in polipropilene antiultravioletti con schienale fissaggio diretto sulla gradinata con tasselli (non inclusi)
 Polypropylene Seat anti ultraviolet rays, with back rest to be fixed with screws (not included)

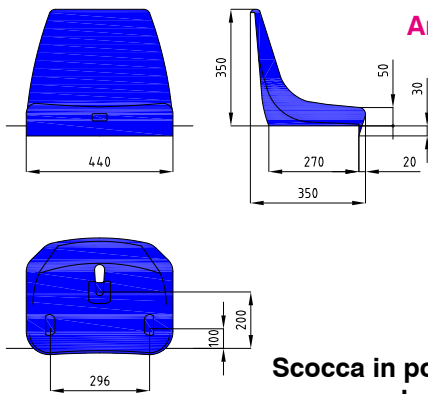

Art. M2008



Scocca in polipropilene con schienale ignifuga e antiultravioletti Art. M2008 oppure solo antiultravioletti Art. M2008A - fissaggio diretto sulla gradinata con tasselli (non inclusi)
 Polypropylene Seat non ignitable and anti ultraviolet rays **Art. M2008** or only anti ultraviolet rays **Art. M2008A** with back rest to be fixed with screws (not included)

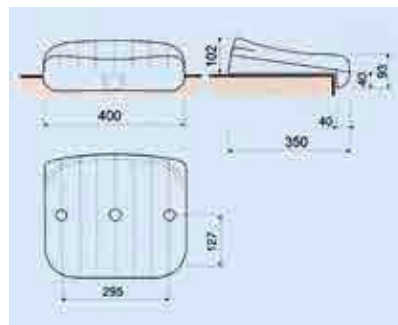
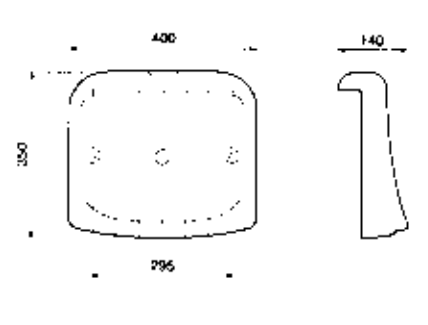

Art. M90

Scocca in polipropilene ignifuga e antiultravioletti - senza schienale fissaggio diretto sulla gradinata con tasselli (non inclusi)

Polypropylene Seat non ignitable and anti ultraviolet rays, without back rest - to be fixed with screws (not included)

Art. M90.A

Scocca in polipropilene antiultravioletti - senza schienale fissaggio diretto sulla gradinata con tasselli (non inclusi)

Polypropylene Seat anti ultraviolet rays, without back rest - to be fixed with screws (not included)

ARREDI PER SPOGLIATOIO - Dressing Room Benches



Altre lunghezze disponibili: m. 1 e m. 1,5
Also available: length 1 and 1,5 meters

Profondità seduta cm. 35
altezza massima cm.185
Depth 35 cm.
height 185 cm.

Art. S07310

Panca con schienale, appendiabiti e portaborse in acciaio verniciato con listoni in legno lunghezza m. 2

Complete Bench in painted steel and wood length m. 2



Art. S07320

Tavola attaccapanni con tettuccio lunghezza m. 2
Top side only in painted steel and wood length m. 2

Art. S07314

Panca completa doppia per centro stanza m. 2 in acciaio verniciato con listoni in legno
Double bench in painted steel and wood length m. 2

pg.32



ALTRI ARTICOLI SUL LISTINO PREZZI



Art. S07306

Panca in acciaio verniciato con listoni in legno m. 2 con schienale
Bench in painted steel and wood length m. 2 with back rest



Art. S07302

Panca in acciaio verniciato con listoni in legno m. 2
Bench in painted steel and wood length m. 2

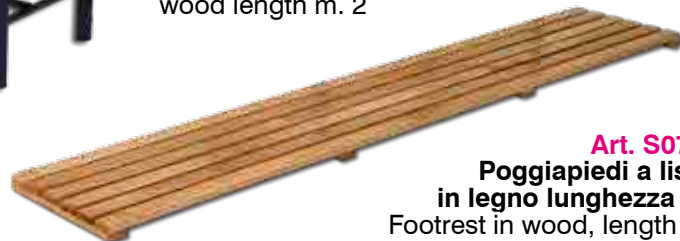

Art. S07404

Poggiapiedi a listoni in legno lunghezza m. 2
Footrest in wood, length m. 2



Art. V8626

Profondità seduta cm. 35
altezza massima cm.185
Depth 35 cm.
height 185 cm.

Art. V8627

Art. V9093

Panca con schienale, appendiabiti e portaborse in alluminio anodizzato con inserti in Pvc lunghezza m. 1 Art. V8626 oppure lunghezza m. 2 Art. V8627
Complete Bench in anodized aluminium length m. 1 **Art. V8626** or length m. 2 **Art. V8627**

pg.32

Pedana poggiapiedi in alluminio anodizzato lunghezza m. 1 Art. V9092 oppure lunghezza m. 2 Art. V9093
Footrest in anodized aluminium length 1 or 2 meters



Art. S07408
Pedana poggiapiedi in plastica cm. 50x50
Plastic footrest 50x50cm.



Art. S07434
Graticcio per doccia in legno cm. 60x60
Wooden footrest 60x60cm.



Art. S07466
Asciugacapelli elettrico con temporizzatore e tubo flessibile
Hair dryer with timer and flexible pipe

pg.33

Art. S07458
Asciugamani elettrico con temporizzatore
Hand dryer with timer



Art. TPD Footsy poggiapiedi idrorepellente
Foldable foot rest water-proof

ALTRI ARTICOLI SUL LISTINO PREZZI



Art. S07462
Asciugacapelli elettrico con temporizzatore
Hair dryer with timer



ARMADIETTI PER SPOGLIATOIO Dressing Room Lockers



Art. S07226
A 15 posti dimensioni totali
overall dimensions
cm. 103Lx35x180h

pg.34



Art. MAP30
Armadio portavalori a 30 sportelli
dim. cm. 50hx95Lx20p con serrature
Safe-deposit locker with 30 boxes

Art. MAP50
Armadio portavalori a 50 sportelli
dim. cm. 82hx95Lx20p con serrature
Safe-deposit locker with 50 boxes



Art. S07252 - S07254 - S07256
Armadio spogliatoio in laminato
dim. vano cm.30Lx50px90h.
1 colonna 2 vani
2 colonne 4 vani
3 colonne 6 vani
Laminated Lockers

Art. S07258 - S07260 - S07262
Armadio spogliatoio in laminato
dim. vano cm.30Lx50px180 h.
1 colonna 1 vano
2 colonne 2 vani
3 colonne 3 vani
Laminated Lockers



Art. S07450
Specchio a parete
con cornice in plastica
diam.cm.60
Wall mirror with frame
diameter 60 cm.

Art. S07438
Distributore di sapone
liquido a parete
Wall soap dispenser



Art. S07442
Distributore di salviette a parete
Wall towel dispenser



ALTRI ARTICOLI SUL
LISTINO PREZZI



Art. S07412
Tavolo per
spogliatoio e
locale arbitri
cm. 80x80x76
Locker room
table
80x80x76 cm.

pg.33



Art. S07416 **Bacheca**
con struttura in alluminio cm. 120x90
Bulletin Board

Art. S07414
Sedia in acciaio cromato
scocca in polipropilene
Chromed steel chair
with polypropylene seat



Art. S07418
Portaombrelli a 24 posti
in acciaio verniciato
Steel umbrella stand



Art. S07684 **Spazzolone**
per pulizia e asciugatura
area pubblica e campo di gioco
Scrubber for cleaning playground

ACCESSORI PER SPOGLIATOIO E INFERMERIA - DRESSING ROOM AND INFIRMARY ACCESSORIES



Art. S07102 - S07104
Armadio a vetri a 1 o 2 porte
Glass Cabinet with 1 or 2 doors



Art. S07106 Paravento a 3 ante
struttura in acciaio cromato
Three shutter screen foldable

ALTRI ARTICOLI SUL
LISTINO PREZZI



Art. S07138
Cassetta medica secondo DM 388
First aid kit

pg.33

pg.34



Art. S07128
Scaletta scendiletto
in acciaio cromato
Bedside step



Art. S07124
Sgabello girevole
in alluminio
Turnable stool



Art. S07108
Appendiabiti a colonna
in acciaio cromato
Clothes stand



Art. S07132
Cestino in plastica
Plastic trashcan

Art. S07130
Portarifiuti
a pedale
in acciaio
verniciato
Metal trashcan



Art. S07134
Barella pieghevole
in acciaio cromato
Foldable Stretcher in
chromed steel



Art. S07110
Scrivania con cassetteria
dim. cm.130x76x78
Desk with 3 drawers dimensions 130x76x78 cm.



Art. S07114
Sedia imbottita, in acciaio cromato Chair in chromed steel

Art. PBN
Bilancia pesa persone con statimetro
Scales with height measurer



Art. S07410
Tavolo per massaggi in acciaio imbottito in similpelle
Massage table



● pg.34

Art. ISBMG
Bilancia massa grassa
Scales with body fat



Art. 3031S
Lettino Antero chiudibile testata regolabile
cm.180x60x73
Peso Kg.20
colore nero
in acciaio cromato
Medical couch foldable in chromed steel



Art. 3033S
Borsone portalettino Antero
Bag for Art. 3031S

Art. S07118
Portarotolo
Paper roll holder

Art. S07120
Rotolo carta
Roll of paper



Art. S07116
Lettino visita medica imbottito con testiera inclinabile
Medical couch in chromed steel, padded, adjustable headrest

TUNNEL USCITA SPOGLIATOI - STADIUM TUNNELS



*** Lunghezza, larghezza e altezza personalizzabili su richiesta**
*** Any dimension available on request**



Art. 160 Tunnel estensibile struttura in lega d'alluminio, copertura in PVC ignifugo Cl.2 bianca o colorata, montato su ruote in pvc, dimensioni tipiche (personalizzabili): larghezza cm. 200, altezza al centro cm.235, in moduli da un metro
Extensible Tunnel in light alloy covered by fireproof PVC Cl.2, white or colored, movable on Pvc wheels - Standard dimensions 200 cm. width - 235 cm. height in the middle, made of 1 meter segments joined together

pg.31

AREA MULTISPORT



Art. AMG16

AREA MULTISPORT misure metri 8x16 con porte m.3x2 (pavimentazione esclusa) struttura portante in acciaio zincato e pannelli in resina melaminica per esterno (prodotto completamente personalizzabile su richiesta)

Multisport Area size 8x16 mt. with futsal goals (pitch not included)

New!

TAVOLI CALCETTO Soccer tables



Art. IS432
Confezione 10 palline per
tavolo calcetto
10 Soccer table balls

pg.44



Art. GA-F1
Tavolo calcetto in legno
modello F1
dim.cm.121x92x78h
aste telescopiche
ideale per bambini
Soccer table model F1
very good for children



Art. FTAT
Tavolo calcetto
modello Atlantis
senza gettoniera,
aste cromate telescopiche,
gambe in ferro verniciato,
piano in formica,
peso kg. 55
Soccer table model Atlantis,
telescopic, legs in painted steel,
weight 55 Kg.

Art. FTGO.G
Tavolo calcetto modello Pride
con gettoniera, aste cromate
telescopiche, gambe in ferro
verniciato, piano in multistrato,
peso kg. 73
Soccer table model Pride, telescopic,
legs in painted steel, weight 73 Kg.

Disponibile anche tavolo
calcetto modello Pride
senza gettoniera **Art. FTGO**
oppure tavolo calcetto
modello Pride con gettoniera e vetro
protettivo ad alta resistenza
peso kg. 85
Art. FTEC



Also available Soccer table model Pride
with no coin slot Art. FTGO
and Soccer table model Pride with coin slot
and high resistance safety glass
Art. FTEC (weight 85 kg.)

BASKET

Art. 0873

Impianto Basket monotubolare con sbalzo mt. 2,20 zincato completo di tabelloni in resina melaminica canestri e retine
Basketball monotubular system galvanized with boards for outdoor

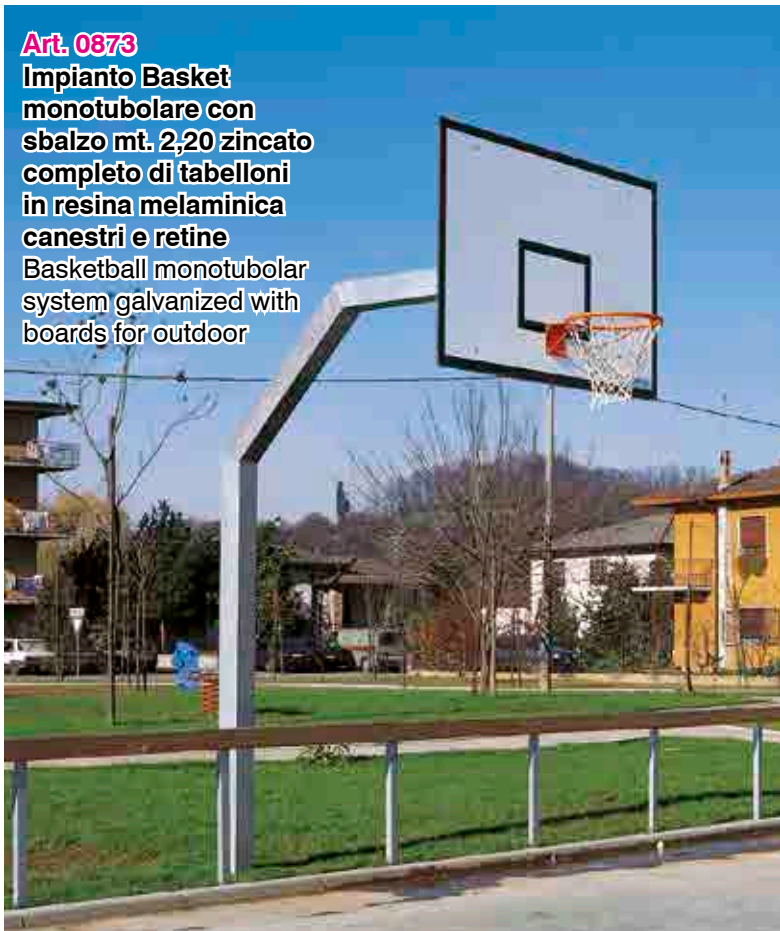

Art. B2235

Coppia protezioni imbottite per impianto basket monotubolare, h. cm. 200
Pair of soft protections for Art. 0873



Art. V4267
Set protezioni frontali con pannello in legno rivestito in PE sp.mm.20
Pair of soft protections for Art.V4248

Art. V4248
Impianto basket monotubolare trasportabile tabelloni in legno regolabili in altezza sbalzo cm. 165 canestri e retine
Monotubular transportable basketball system



pg.34



Art.0857/0862/0858/0863
Impianto Basket a traliccio zincato, sbalzo mt. 2,20 fisso o mobile su ruote completo di contenitori in bilaminato o in resina melaminica, canestri e retine
Basketball system in galvanized steel, with wooden or outdoor boards, fixed or transportable models

Art. B2084

Coppia protezioni imbottite per impianto basket a traliccio, dim. cm. 200x130
Pair of soft protections for basketball system dimension 200x130cm.

pg.35

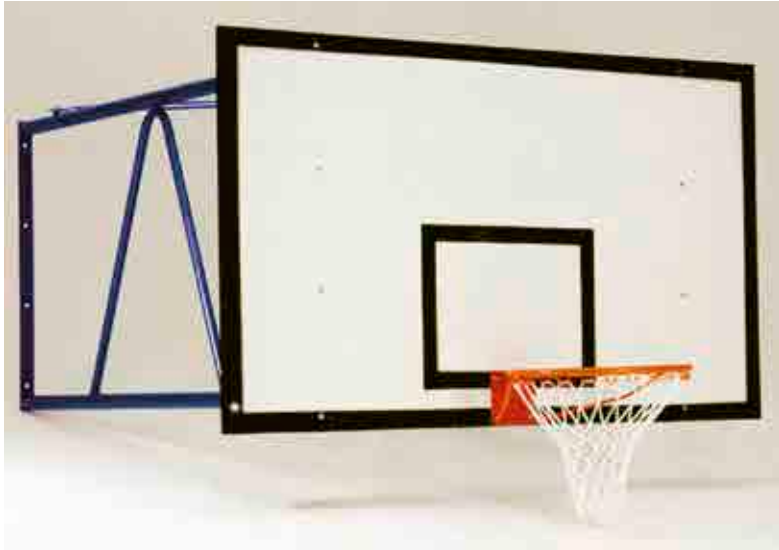

Art. S04056 - S04058
Impianto basket a muro fisso con sbalzo cm. 185 oppure cm. 325, tabelloni in bilaminato, canestri e retine
Wall basketball system projection 185 or 325 cm.
wooden boards, rings and nets



Art. S04054
Impianto basket a muro
fisso sbalzo cm. 80 tabelloni in bilaminato
canestri e retine
Wall basketball system projection 80 cm.

pg.34

pg.35



Art. S04004
Basket/minibasket a colonna
in acciaio con bossola
altezza regolabile
tabellone in plastica
canestro e retina
Single basketball steel post with
socket, plastic backboard,
ring and net



Art. S04052
Basket/minibasket a muro
regolabile in altezza
canestro e retina
Single wall basketball adjustable height



Art. S04160
Coppia strutture minibasket
agganciabili a tabelloni basket
complete di tabelloni in
bilaminato, canestri e retine
(attrezzo per sollevamento
tabelloni non incluso)
Pair or mini-basketball
constructions to be attached to
basketball backboards
(rising tool in the picture
not included)



Art. 0987
Impianto minibasket a colonna regolabile in altezza e trasportabile, fornito con canestri e retine
 Transportable mini-basket system

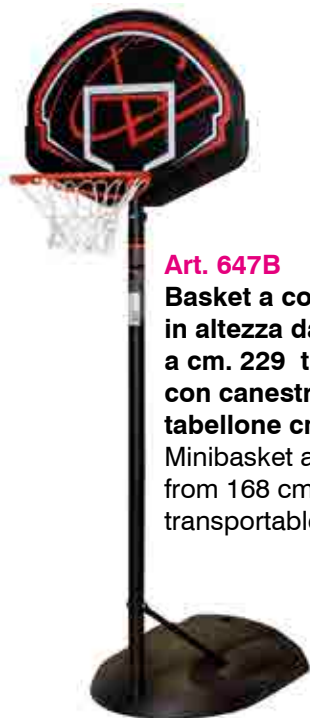

Art. 647B
Basket a colonna regolabile in altezza da cm. 168 a cm. 229 trasportabile, con canestro e retina tabellone cm. 90x60
 Minibasket adjustable height from 168 cm. to 229 cm. transportable

pg.35



Art. 26759
Basket a colonna regolabile in altezza da cm. 229 a cm. 305 trasportabile, con canestro e retina tabellone cm.120x70 - rinforzato
 Minibasket adjustable height from 229 cm. to 305 cm. transportable



Art. 0989
 Util Basket Super

Art. 0990
 Util Basket Normale



Art. 26760
Tabellone minibasket da fissare al muro, fornito con canestro e retina
 Wall minibasket board



Art. 45097
Micro tabellone con palla
 Wall micro board with ball



Art. PPV01
Protezione monotubolare singola in nylon idrorepellente con velcro cm. 180x9x2 per Art. 647B e 26759
 Single monotubular soft protection for Art. 647B and 26759



Art. F102
Canestro Basket regolamentare
(retina esclusa)
Basket standard



Art. B030
Coppia Retine in nylon
mm.3,5
Pair of nets mm.3,5



Art. F103
Canestro Basket rinforzato
(retina esclusa)
Basket reinforced



Art. B060
Coppia Retine in
cotone mm. 7
Pair of nets mm.7



Art. F105
Canestro Basket zincato
(retina esclusa)
Basket galvanized



Art. R122
Coppia Retine in acciaio
Pair of steel nets



Art. F106
Canestro Basket reclinabile, a norme FIBA
(retina esclusa)
Reclining Basket



Art. S04236
Canestro Basket reclinabile, omologato
a norme FIBA (retina esclusa)
Approved reclining Basket

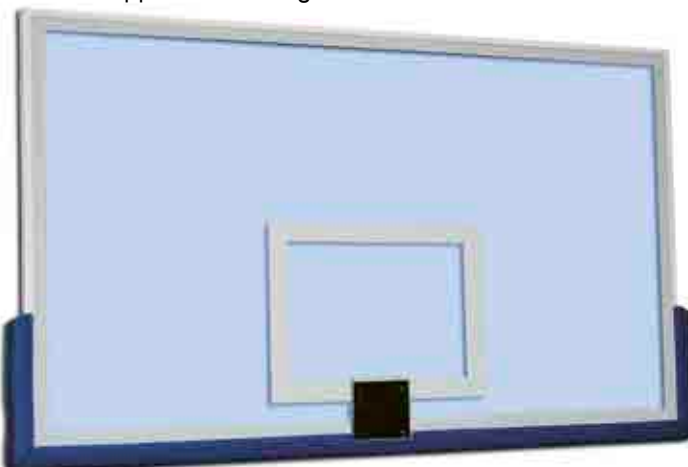

Art. NRG C
Gancio reggi rete in
plastica per canestro
basket
Plastic net holder

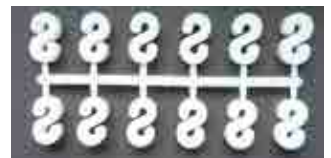

pg.35

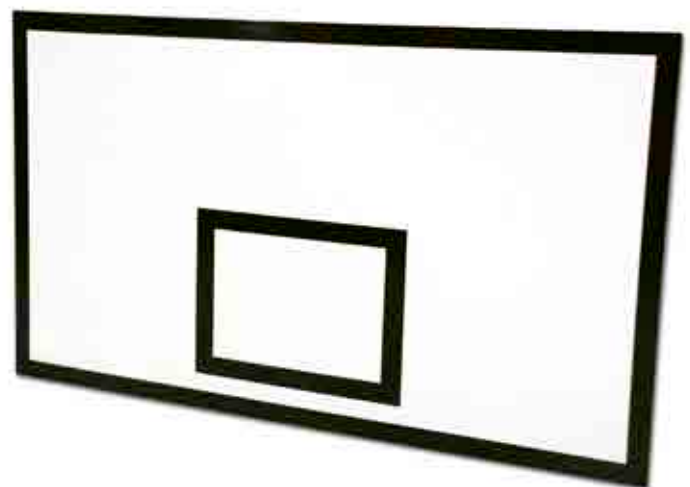

Art. S04202 - F116/C - S04204 - F116/B
Coppia tabelloni in bilaminato per interno
oppure in resina melaminica per esterno
varie dimensioni

Pair of basketball boards in chipboard for indoor
or in hpl for outdoor, various sizes

Art. S04206 - S04208
Coppia tabelloni in Plexiglass trasparente
oppure cristallo temperato dimensioni
cm. 180 x 105 - compreso telaio e protezione
Pair of basketball boards in trasparent acrylic
or tempered glass 180 x 105 cm.
mounted onto varnished steel frame with pads

Art. B2063B - B2063
Coppia Protezioni sotto canestro omologate FIBA e non
Pair of soft board protection pads FIBA approved or not



Art. S04266
Protezione mobile per tavolo giuria e atleti in policarbonato trasparente
 Transparent movable polycarbonate protection for benches and referees' table

Art. S04254
Panca per atleti e riserve con poggiaschiena m.3
 Bench length 3 meter with back rest

pg.35



Art. S07514 pg.46
Elemento di separazione e protezione bordo campo cm. 200x50x75 h. in gomma espansa rivestita in PVC
 Rubber bound for floor delimitation size 200x50x75 h. cm.



Art. S04256
Tavolo giuria cm. 160x80x76h.
 Referee table



Art. S04258
Tavolo giuria cm. 240x90x76h.
 Referee table

pg.36



Art. S04288
Freccia indicatrice possesso palla
 Ball possession arrow



Art. P5006
Freccia indicatrice elettronica possesso palla
 Electronic ball possession indicator



Art. S04262
Tavolo giuria cm. 300x70x76h. carenato su ruote
 Referee table on wheels



Art. CR016
Cronometro contasecondi da tavolo a pila con display digitale
 Digital Table Clock for basketball



Art. CR005
Cronometro contasecondi da tavolo a pila con lancette
 Table Clock for basketball



Art. S04280
Segnapunti
manuale
girevole
a 6 cifre
 6 figure
 Scoreboard



Art. S04274
Serie Palette 24"
 Set of 24 sec indicators



Art. B01084
Segnapunti per Basket da tavolo
 Table scoreboard

● pg.36



Art. S04272
Serie palette per giudici
 Set of referee's foul indicators



Art. S04282
Segnapunti manuale a parete a 6 cifre, struttura in acciaio verniciato
 Wall steel 6 digit scoreboard

Art. 089-B
Lavagna cancellabile
Basket cm. 40x23
 Basket Tactic Board
 erasable 40x23 cm.

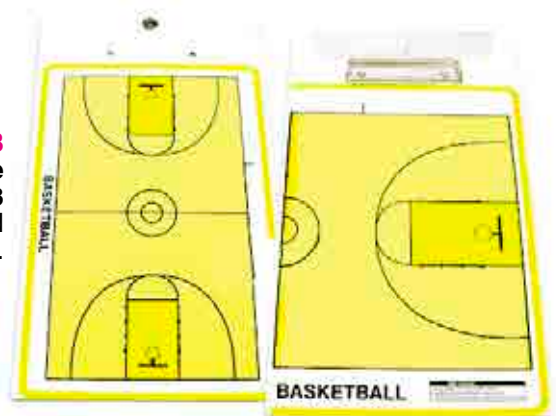

Art. 087-B
Lavagna magnetica
Basket cancellabile
cm. 60x85
 Basket Tactic Board erasable and magnetic 60x85 cm.



Art. LSRK
Lavagna magnetica Basket cm. 40x23
con block notes Basket Tactic Board magnetic 40x23 cm. with block notes



Art. B3002 Pallone Basket e Minibasket gomma nylon misure 3-5-7
Nylon rubber Basket and Minibasket ball



Art. MSBK6 Pallone Basket Mondo gomma nylon n.6
Nylon rubber Basket Mondo Size 6 ball



Art. MSBK4 Pallone avviamento al Minibasket Mondo gomma nylon misura 4
Minibasket introduction



Art. SB4Y Pallone avviamento al Minibasket Molten gomma nylon misura 4
Minibasket introduction

New!

pg.36



Art. BGR5 Pallone Minibasket Molten BGR5 gomma nylon
Nylon rubber Minibasket Molten BGR5 ball



Art. BGR7 Pallone Basket Molten BGR7 gomma nylon
Nylon rubber Basket Molten BGR7 ball



Art. BGE6 Pallone Basket Molten BGE6 pelle sintetica n. 6 (disponibile fino ad esaurimento scorte)
Leather Basket Molten BGE6 ball (until available in stock)



Art. BGM7/BGM6 Pallone Basket Molten BGM7/BGM6 pelle sintetica n. 7/6 FIBA Approved
Leather Basket Molten BGM7/BGM6 ball

Art. BGF7/BGF6 Pallone Basket Molten BGF7/BGF6 pelle sintetica ufficiale FIP Serie B e C
Leather Basket Molten BGF7/BGF6 balls



Art. BGG7/BGG6 Pallone Basket Molten BGG7/BGG6 pelle sintetica ufficiale FIP Serie A1 e A2
Leather Basket Molten BGG7/BGG6 balls



Art. TRBB Pallone reaction ball Trial rimbalzo e traiettorie imprevedibili per basket
Trial Reaction Ball unpredictable rebounds



Art. BYCB Pallone basket bicolore gomma Trial Ø cm.24 - gr. 620
Trial bi-color rubber Basketball



Art. ULTS67 Pallone basket gomma Trial allenamento potenziato Ø cm. 24 gr. 930 (+50%)
Rubber Trial Heavier Basketball



Art. ULTD67 Pallone basket gomma Trial allenamento potenziato Ø cm. 24 gr. 1240 (+100%)
Rubber Trial Heavier Basketball

PALLAVOLO - VOLLEYBALL

Art. 6746T



Art. 6746T
Impianto pallavolo
monotubolare
in acciaio zincato
Ø 76 mm.
completo di bossole
da interrare cm. 40
e tendirete
altezza della
rete regolabile
 Volleyball posts in
 galvanised steel with
 underground bases
 adjustable height net

pg.37

Disponibile anche:
Also available:

Art. V5003

Impianto pallavolo
monotubolare
in acciaio zincato Ø 70 mm.
completo di bossole
da interrare e tendirete
con sistema periscopico
per la regolazione
dell'altezza dei pali
e della rete
 Volleyball posts in
 galvanised steel with
 underground bases
 periscopic posts
 adjustable height net



IMPIANTO
= coppia pali
(rete esclusa)



Art. V5009



Art. V5009
Impianto
pallavolo
monotubolare
in alluminio T6
antiflessione
mm. 120x100
con arganello
tendirete
autofrenante
e senza
cremagliera
con manovella
asportabile - bossole
e tappi in alluminio
 Aluminium
 monotubular
 volleyball posts

pg.38

Art. 6747/P
Impianto pallavolo
monotubolare a norme FIPAV
in alluminio sezione
mm. 120x100
regolazione dell'altezza
dei pali e della rete
con sistema periscopico
con arganello tendirete
e bossole incluse
 Aluminium monotubular
 volleyball posts
 periscopic system
 FIPAV approved

La regolazione
periscopica permette di
variare l'altezza dei pali
oltre a quella della rete
(che può essere regolabile
da cm. 200 a cm. 250)



Art. 6747/P

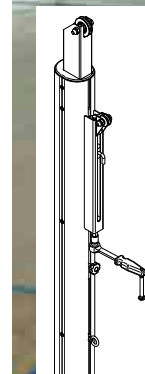

Art. MB2083 Coppia
Protezioni in gommapiuma
rivestita per
impianto monotubolare
 Pair of soft protections
 for volleyball posts

Art. S04704
Impianto
Pallavolo
a parete
 Volleyball
 post for
 wall fixing



Art. 6740
Impianto pallavolo a traliccio ø 70 mm. in acciaio verniciato completo di tendirete
Volleyball post in painted steel transportable



Art. 1006
Impianto pallavolo a traliccio ø 70 mm. in acciaio verniciato completo di ruote e tendirete
Volleyball posts in painted steel transportable with wheels

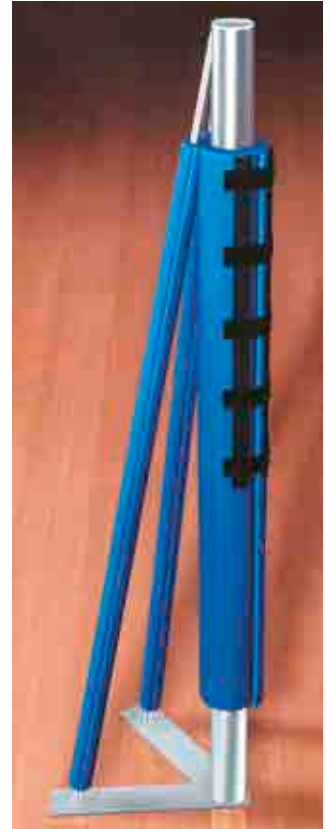

Art. MB2236 Coppia protezioni in gommapiuma rivestita per impianto a traliccio
Pair of soft protections for volleyball posts



Art. 1009
Impianto pallavolo a traliccio in alluminio ø mm. 120x100 dotato di ruote e tendirete
Volleyball posts in aluminium transportable with wheels, pipe section 120x100 mm.

● pg.38

IMPIANTO = coppia pali (rete esclusa)

Art. V5029
Impianto pallavolo a tiranti ridotti in lega di alluminio profilo sezione mm. 120x100 con ruote per il trasporto piastra anti torsione alla base, arganello tendirete autofrenante senza cremagliera anti infortunistico
Volleyball posts in aluminium transportable with wheels, pipe section 120x100 mm.





Art. P030
Rete pallavolo m. 9,50
Net for Volleybal

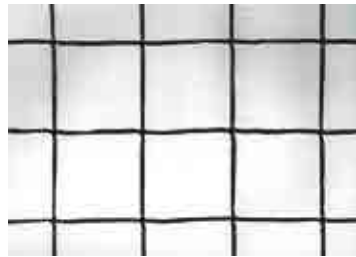

Art. P100
Rete pallavolo super pesante
m. 9,50
Heavy net for volleyball



Art. P200
Rete pallavolo da
gara con antenne
e tasche
a norma FIPAV
Official net for
volleyball



Art. P14
Coppia antenne in vetroresina divise

Art. P15
Coppia bande
verticali cm. 5

Art. P16
Coppia antenne in
vetroresina intere



Art. PP054
Segnapunti manuale
da tavolo per Pallavolo
(numeri da 1 a 50 non divisi)
Volleyball table scoreboard

pg.38

Art. S04814
Segnapunti
manuale
girevole
a 4 cifre
4 figure
scoreboard



Art. 1019
Seggiolone
arbitro pallavolo
in piedi
Referee's stand



Art. 1020
Seggiolone arbitro
pallavolo approvato
F.I.P.A.V. regolabile
in altezza con
scaletta di accesso
e ruote per trasporto
Referee's chair



Art. S04816
Serie 18 Palette
sostituzioni giocatori
con contenitore
Set of 18 substitution
indicators



Art. 089-V
Lavagna per Pallavolo
cancellabile cm. 35x25
Volleyball Tactic Board
erasable cm. 35x25



Art. V5081
Simulatore di muro su ruote in acciaio zavorrato con pannello a superficie irregolare
 Portable wall in painted steel with irregular surface board



Art. V5082
Simulatore di muro portatile per squadre femminili e giovanili
 Portable wall for women and kids

pg.38

pg.39

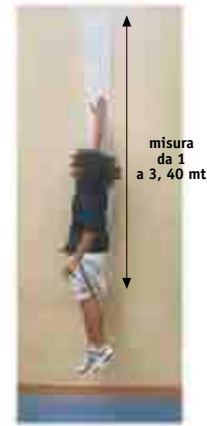

Art. P11032
Misuratore di elevazione da fissare a muro (misura l'elevazione da 1 a 3,40 metri)
 Wall jump meter in plastic (up to 340 cm.)

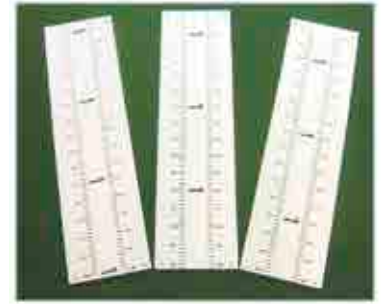

Art. V5051 **Jump Tester in acciaio zincato telescopico regolabile da cm. 230 a 380 (basamento non incluso)**
 Jump Tester in painted steel telescopic adjustable height from 230 to 380 cm. (base not included)



Art. V5070
Ball Catcher cm.70x70 altezza regolabile da cm.190 a 320 con anello superiore inclinabile, basamento e retone inclusi
 Ball catcher, adjustable height and inclination (base and net included)

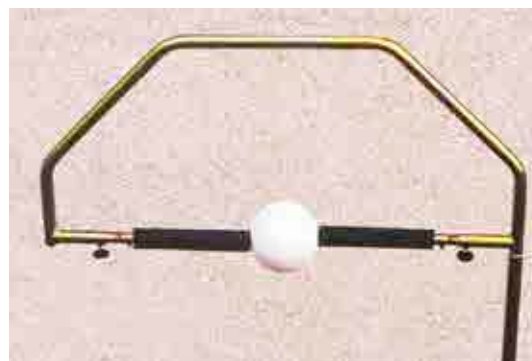

Art. V5060 **Spike con ganasce (basamento non incluso)**
 (base not included)

Art. V5050
Basamento zavorrato multiuso per Ball Catcher, Spike, Jump Tester
 Multi-purpose weighted base





Art. V20
Pallone Volley Trial
 in gomma monostrato
 Single stratum Trial Volley ball



Art. ULT20-3
Pallone Volley Trial
 in gomma
 triplo strato
 Triple stratum
 Trial Volley ball

Art. MVBS
Pallone Volley
Mondo VBS
 peso ridotto
Under 13
 Under 13 Mondo
 Volley ball



Art. E6835
Pallone Volley
Soft Touch in PU
 saldato, regolamentare,
disponibile da ottobre 2013
 Official size and weight volleyball
 available from October 2013

New!

pg.39



Art. 18335
Pallone Volley School
 Molten Under 13
 peso ridotto V5M2501-L
 Under 13 Molten Volley
 School ball



Art. 29096
Pallone Volley Pelle
 Molten allenamento
 Ultra Touch V5M1500
 Molten Volley training ball



Art. 6036
Pallone Volley Molten
 V5M4000



Art. 6331
Pallone Volley gara
 Molten V5M5000
 "FLISTATEC" FIVB
 Approved



Art. BYCV
Pallone Volley Trial
 gomma bicolore



Art. TRBV
Pallone Reaction
 Ball Trial
 doppio strato
 per Volley
 rimbalzo e
 traiettorie
 imprevedibili
 Trial Volley ball for
 unpredictable
 rebounds



Art. MTVSC
Pallone Volley Molten
 Serve Cut



Art. USE20
Pallone Volley Trial
 gr. 405 (+50%) ø cm. 21
 per allenamento
 potenziato



Art. ULTD20
Pallone Volley Trial
 gr. 540 (+100%) ø cm. 21
 per allenamento
 potenziato

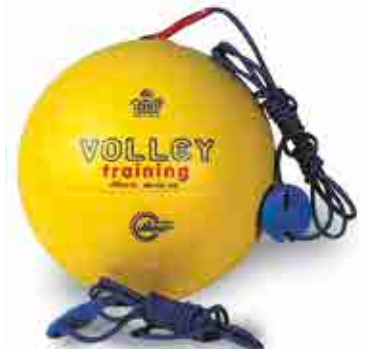

Art. ULT22
Pallone Volley Trial
 training con 2 elastici

MINI-VOLLEY

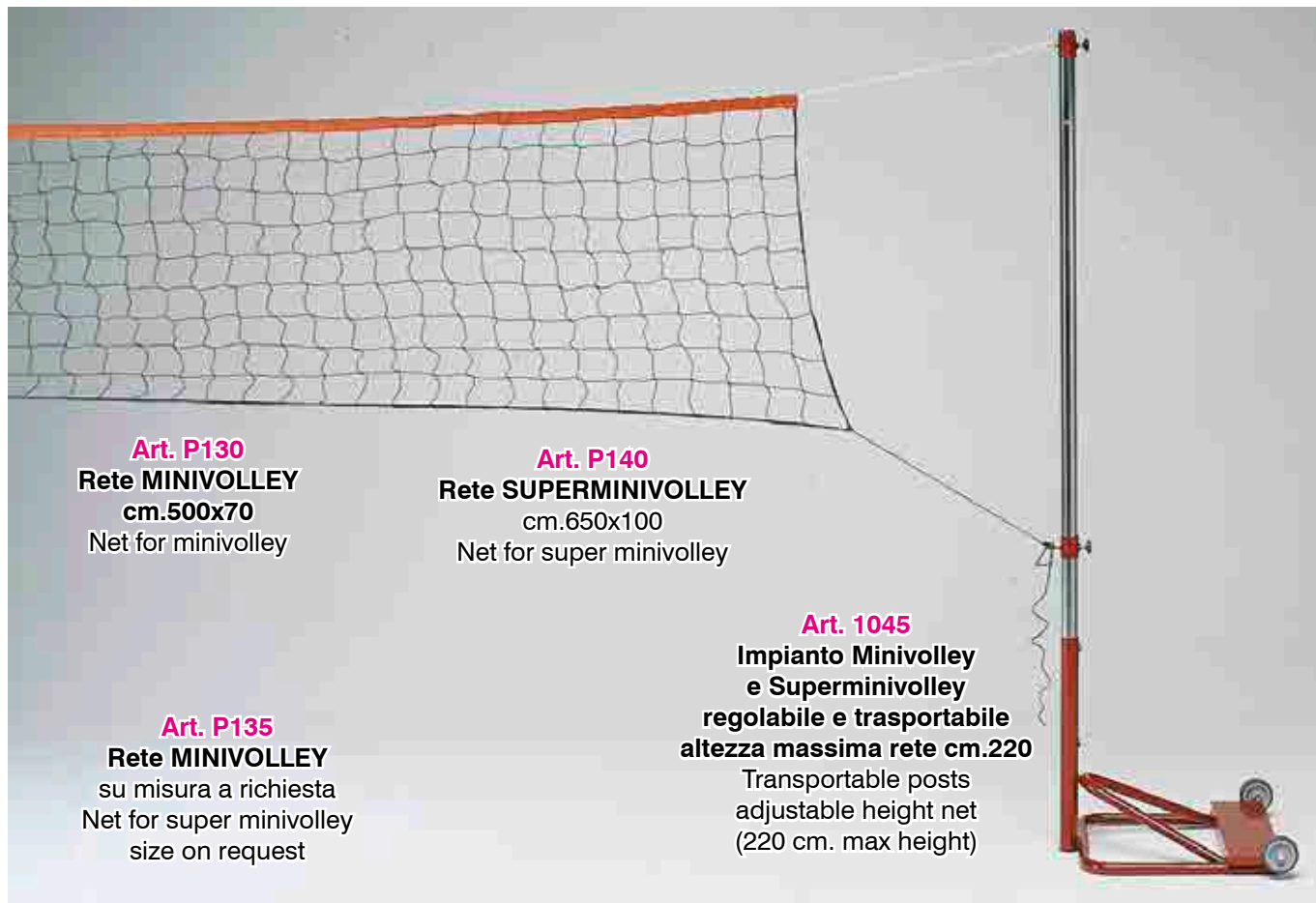

Art. P130
Rete MINIVOLLEY
cm.500x70
Net for minivolley

Art. P140
Rete SUPERMINIVOLLEY
cm.650x100
Net for super minivolley

Art. P135
Rete MINIVOLLEY
su misura a richiesta
Net for super minivolley
size on request

Art. 1045
Impianto Minivolley
e Superminivolley
regolabile e trasportabile
altezza massima rete cm.220
Transportable posts
adjustable height net
(220 cm. max height)

pg.39 pg.40



Art. 191S
Pallone
MINIVOLLEY
in gomma
Rubber Minivolley
ball



Art. 191SM
Pallone
SUPERMINIVOLLEY
in gomma
(ad esaurimento)
Rubber
Superminivolley ball



Art. V33
Pallone
MINIVOLLEY
in gomma Trial
Trial rubber
Minivolley ball



Art. V27
Pallone
SUPERMINIVOLLEY
in gomma Trial
Trial rubber
Superminivolley ball



Art. ULT26-3 / ULT27-3
Pallone MINIVOLLEY/
SUPERMINIVOLLEY
in gomma
triplo strato Trial



Art. MV140
Pallone MINIVOLLEY
"First Touch" Molten
nylon gr.140



Art. MV210
Pallone MINIVOLLEY
"First Touch" Molten
nylon gr.210



Art. 6332
Pallone
MINIVOLLEY
in gomma Molten

BEACH-VOLLEY

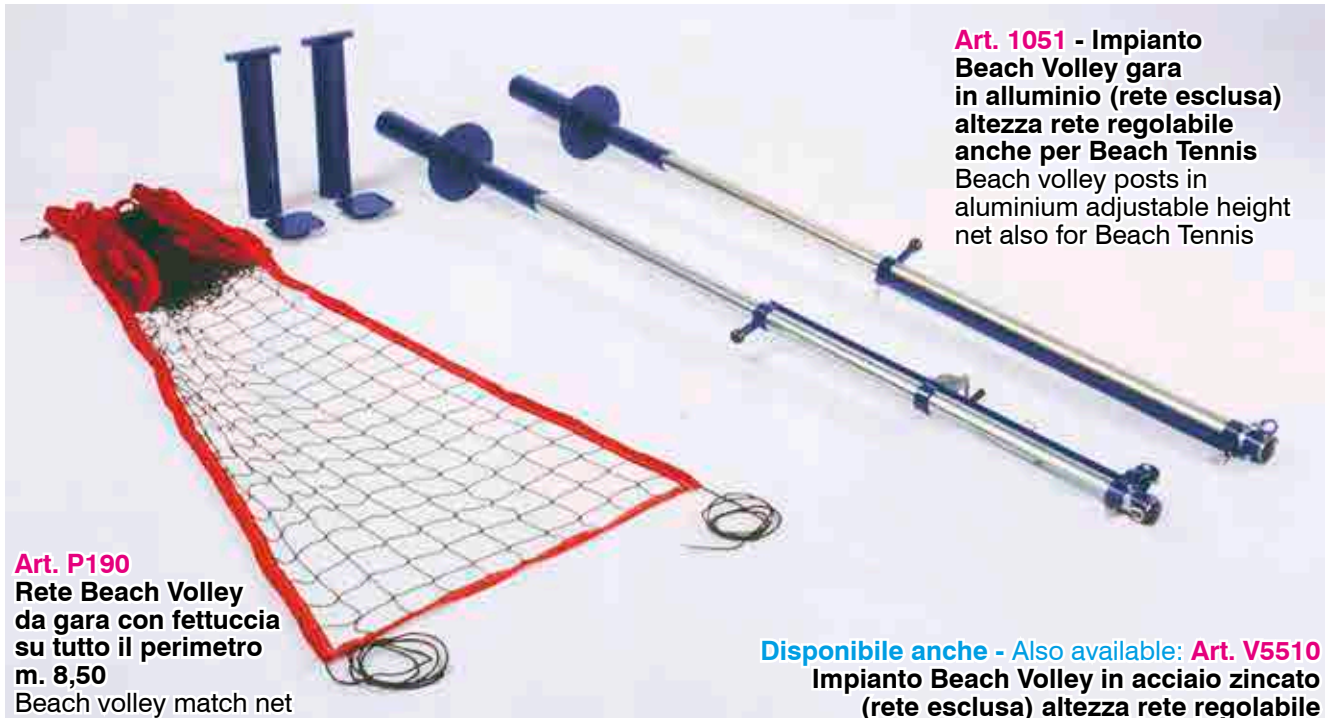

Art. P190
Rete Beach Volley
da gara con fettuccia
su tutto il perimetro
m. 8,50
Beach volley match net

Art. 1051 - Impianto
Beach Volley gara
in alluminio (rete esclusa)
altezza rete regolabile
anche per Beach Tennis
Beach volley posts in
aluminium adjustable height
net also for Beach Tennis

Disponibile anche - Also available: Art. V5510
Impianto Beach Volley in acciaio zincato
(rete esclusa) altezza rete regolabile
anche per Beach Tennis
Beach volley posts in galvanized steel
(net not included) adjustable height
net also for Beach Tennis



Art. P170 - Rete Beach Volley m. 8,50
Beach volley net

pg.40

Art. BVMBP
Coppia protezioni
per impianto Beach
Volley regolamentare
altezza cm. 200
diametro cm. 8
Pair of Beach volley
soft protections



Art. F501

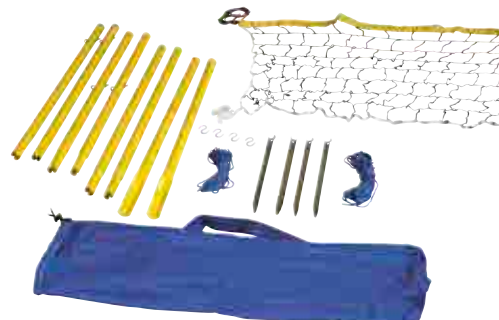

Art. F501 Impianto Mini Beach Volley portatile a pali telescopici in ferro verniciato giallo
completo di rete mt.6,5x1 e sacca
Mini Beach volley complete set



Art. V5543

Seggiolone per arbitro Beach Volley in acciaio ovale verniciato a polveri sez. mm.60 antinfortunistico e richiudibile in soli 45 cm. Beach Volley referee's Stand

Art. V5428

**Set imbottiture per seggiolone Art.V5543
Set of Soft Protections for Art.V5543**



Art. P17

**Kit Delimitazione campo Beach Volley
(2 nastri m.16 + 2 m. 8 + 8 picchetti + 8 elastici)
nastri mm. 50 - occhiellati alle estremità
Set for Beach Volley Bounds**



Art. P19 - Kit Delimitazione colore blu

**regolabile per campo Beach Volley e Beach Tennis
(2 nastri m.16 + 2 m. 8 oppure 2 nastri m.18 + 2 m. 9)
Set for Beach Volley and Beach Tennis bounds adjustable blue color**



Art. M820

**Pallone Beach Volley
in pelle sintetica**

pg.40



Art. 6340

**Pallone Beach Volley
da gara Molten BV5000
Pallone ufficiale FIVB**



Art. 29097

Pallone Beach Volley Molten "Sweet Touch"

New!

IMPIANTI MULTIFUNZIONE

Multi-purpose systems



Art. S05206

Impianto multifunzione per volley, minivolley, tennis, badminton e salto in alto base in acciaio verniciato zavorrata su ruote e con staffe per eventuale fissaggio a terra ritto in alluminio centimetrato
Volley, Minivolley, Tennis, Badminton and High Jump transportable system - painted weighted base with wheels also with ground fixing aluminium measurement bar

pg.38

Art. 6780M

Impianto volley e minivolley trasportabile zavorrato
Weighted Volley and Minivolley transportable system



Art. S05208

Coppia tabelloni in plastica con canestro su supporto in acciaio per Art. S05206
Pair of Basket Boards + baskets + steel back frames for Art. S05206

Art. S05206
+
Art. S05208

pg.42



Art. S05202

Impianto multifunzione volley, minivolley, minitennis trasportabile zavorrato strutture verticali in tubolare di acciaio zincato innestabili e agganciabili rete m. 6x1 compresa
Volley, Minivolley and minitennis transportable system

Art. S05204

Impianto multifunzione come Art. S05202 ma valido anche per minibasket (con tabelloni in plastica)
Same of Art. S05202 but also for minibasket (with plastic boards)



Art. PA020
Impianto multifunzione trasportabile completo di protezioni

Volley, Minivolley, Badminton and Beach Tennis transportable system

Altezza rete (non inclusa) regolabile da cm. 91 a cm. 245
Basi in ABS con ruote, riempiabili con sabbia

PALLAMANO Handball

New!



Art. SH1

**Pallone Pallamano in gomma
Trial Street Handball One Goal Game
Trial Rubber Street Handball**



Art. 1096

**Coppia porte pallamano
in alluminio, reti escluse
Pair aluminium handball Goals**

**Le reti per porte pallamano
corrispondono alle reti
per porte da calcio**



Art. IS874

**Pallone Pallamano
pelle sintetica
mis. 2 o mis. 3
Handball size 2 and 3
in synthetic leather**



Art. HXT.2

**Pallone Pallamano
Molten in PU
mis. 2 femminile
Molten Handball size 2
in synthetic leather**



Art. HXT.3

**Pallone Pallamano
Molten in PU
mis. 3 maschile
Molten Handball size 3
in synthetic leather**



pg.40

pg.41

**Art. V29 / V30 / V49 / ULT49-3 / ULT30-3
ULT29-3 / ULT24-3**

**Pallone Pallamano in gomma
Trial (mono e triplo strato) mis. 0,1,2,3
Trial handball in rubber (single and triple stratum)
size 0,1,2,3**



Art. ULT36-3 / ULT37-3

**Pallone Beach Handball in gomma Trial
femminile n. 2 e maschile n. 3
Trial beach Handball in rubber no. 2 and no. 3**

**Art. ULTS29 / ULTD29
ULTS30 / ULTD30
ULTS49 / ULTD49**

**Pallone gomma Trial
potenziato
Ø 15/17/18,5 cm.
gr. 375/500/550/630/
700/750**

**(+50% / +100%)
Rubber Trial Heavier Handball**



Art. TRBH

**Pallone Reaction Ball Trial
doppio strato
rimbalzo e traiettorie imprevedibili
Trial Reaction Ball unpredictable
rebounds - for Handball**



Art. BYCH

**Pallone Pallamano
bicolore gomma Trial
Ø cm.18,5 gr.420
Trial bi-color handball**

PROTEZIONI - Protections



Art. E6644

**Paio ginocchiere Volley trapuntate, misura S, M, L
colori royal, nero, rosso, navy**
Pair of knee protections size S, M, L

pg.39



Art. E6642

**Paio ginocchiere Volley gara, misura JR e SR
colori royal, rosso e nero**
Pair of knee protections for match size JR and SR



Art. 43602A

**Paradenti doppio
taglia S-L**
Double Mouthguard Size S-L

Art. E6641
**Paio ginocchiere Volley professionali,
regolabili con velcro, misura SR**
colori blu e nero
Pair of pro knee protections size SR
adjustable with velcrum
colors black and blue



Art. 9293
**Paradenti singolo
taglia adulto**
Adult Mouthguard

Art. 9293.B
**Paradenti singolo
taglia bambino**
Junior Mouthguard

**Il reggi-paradenti con fori si
può rimuovere (se necessario)**



Art. E6633

**Paio gomitiere Volley, misura JR e SR
colori royal, rosso e nero**
Pair of elbow protections size JR and SR



Art. ESPN
**Maschera di
protezione per
naso, zigomi
e arcata
sopracciliare**
Face Protection
Mask



Art. 73001
**Conchiglia,
misura S,M,L**
Shell Protection
size S, M, L



Art. E6649

Art. E6650

Art. E6670

Art. E6649

Paio ginocchiere elasticizzate misura S, M, L, XL
Pair of elastic Knee Protections size S, M, L, XL

Art. E6650

Paio cosciere elasticizzate misura S, M, L, XL
Pair of elastic Thigh Protections, size S, M, L, XL

Art. E6670

Paio cavigliere elasticizzate misura S, M, L, XL
colore nero o bianco
Pair of elastic Ankle Protections size S, M, L, XL

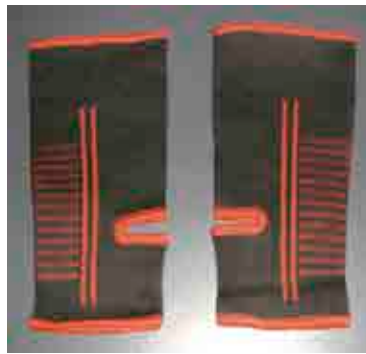

Art. E6670



Art. E795

Ginocchiera in neoprene
taglia S-M-L-XL
Neoprene Knee Protection



Art. IS799

Ginocchiera
con supporti rigidi
taglia S/M - L/XL
Knee protection
with metal support



Art. E798

Supporto Coscia
in neoprene
taglia S-M-L-XL
Neoprene Thigh
Protection



Art. E786

Cavigliera in neoprene
taglia S-M-L-XL
Neoprene Ankle Protection

pg.39



Art. 90252A

Fascia sottrotulea in neoprene
Neoprene underknee band



Art. 2651A

Short in neoprene
vita alta colore nero
taglia S-M-L-XL
Neoprene Shorts



Art. E796

Supporto gomito in neoprene
taglia unica regolabile
Neoprene Elbow Protection
one size fits all

Art. IS785
Panciera in Neoprene
taglia unica altezza cm. 25
Neoprene Stomach band
25 cm. height



TABELLONI ELETTRONICI BASKET, PALLAVOLO, MULTISPORT ELECTRONIC SCOREBOARDS FOR BASKETBALL, VOLLEYBALL, MULTISPORT



Art. F160

Tabellone portatile multisport da tavolo
dim. cm. 55x35x9,5 - con tastiera di comando
per BASKET, VOLLEY, CALCETTO, PALLANUOTO,
PALLAMANO, KICK BOXING, PING-PONG etc.
punteggi da 0 a 199 per lato
set/bonus/falli da 0 a 9 per lato
cronometro massimo 99 minuti e 59 secondi
periodi da 0 a 9 - altezza cifre cm.9
Multisport Table Electronic Scoreboard



Art. F344

Tabellone elettronico PLAY20-V con console solo
tasti e m. 30 di cavo - dim. cm. 85x38x11
h. cifre cm. 17,4 - indicato per VOLLEY,
PING-PONG, BADMINTON, SQUASH
punteggi 0-199 per lato - set/bonus da 0 a 3
per lato - possesso/priorità/turno lato dx o sx
Electronic Board with console, dim. cm. 85x38x11
cm. 17,4 cm. high figures

Art. F344D

Tabellone elettronico PLAY20-V con console
dotata di display - Art. F344 with display console

Art. F344T

Tabellone elettronico PLAY20-V con
telecomando a infrarossi - Art. F344 with remote
control



Art. F355D

Tabellone elettronico MULTISPORT cm.150x98x7
altezza cifre 30 cm. - set/bonus/falli con tastiera
e cavo mt. 60, segnalatore acustico
Electronic Board with console, dim. cm. 150x98x7
30 cm. high figures

Art. F355T

Come articolo F355D ma con telecomando
Art. F355D with remote control



Art. F351

Tabellone elettronico PLAY30-C con console
solo tasti e m.30 di cavo - dim.75x59x10
h. cifre punteggio cm.17,4 - h. cifre cronometro
cm.15 - h. cifre set/bonus/falli cm. 9,4 - indicato
per BASKET, VOLLEY, CALCETTO, PALLAMANO
punteggi 0-199 per lato - set/bonus da 0 a 9 per
lato - possesso/priorità/turno lato dx o sx
cronometro 99:59 - dotato di segnalazione
acustica di fine tempo (escludibile)
Electronic Board with console, dim. cm. 75x59x10
cm. 17,4 cm. high figures

Art. F351D

Tabellone elettronico PLAY30-C con console
dotata di display - Art. F351 with display console

Art. F351T

Tabellone elettronico PLAY30-C con telecomando
a infrarossi - Art. F351 with remote control

pg.36

pg.37

New!

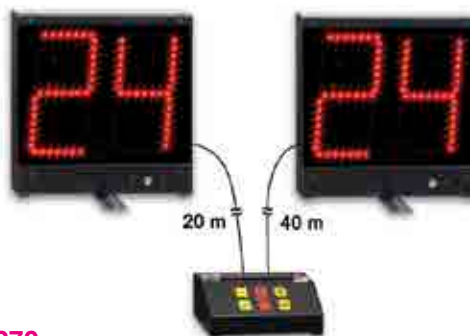

Art. F270

Kit indicatori elettronici 24 secondi
(h. cifre 20 cm.) dim. cm.29,2x30,4x4,4 cadauno,
completo di centralina munita di tastiera,
studiato per la visualizzazione del tempo di tiro
e del time out - segnalatori acustici di fine tempo,
un cavo m. 20 e un cavo m. 40 in dotazione
kit 24 second indicators with console



Art. F242

Tabellone MULTISPORT FS-130
 dimensioni cm. 200x180x9 - peso Kg.60
 costruito secondo le disposizioni FIBA
 utilizzabile per BASKET, VOLLEY, CALCETTO,
 PALLAMANO, HOCKEY, TENNIS etc.
 altezza cifre 30 cm. tempo di gioco 99:59
 punteggi di squadra (da 0 a 199) - periodo (0 - 9)
 falli di squadra/set vinti (da 0 a 9) - bonus
 (1 punto luminoso per squadra)
 timeout (3 punti luminosi per squadra)
 possesso/servizio/turno: frecce indicatrici
 indicazione ultimo fallo avvenuto
 (numero di maglia del giocatore e numero del fallo)
 Electronic Board, dim. 200x180x9 cm.
 30 cm. high figures for various sport

pg.37



Art. F230A/F230B

Console per Art. F242
 completa di cavi
 oppure con trasmettitore radio
 Console for Art. F242 with cable
 or radio system



Art. F258-1

Tabellone elettronico indicatore dei 24
 secondi e tempo di gioco FS-24s-1
 dim.cm.70,5x60x11,5 - h. cifre cm.14 e
 cm.30 - da collegare con Art. F253-01,
 completo di cavo m.60 per collegamento
 alla console Art. F230A - protetto contro
 gli urti della palla
**N.B. Per un impianto Basket completo
 occorrono no. 2 Art.F253-01 + no. 2 Art.
 F258-1**
 24 second indicator board

Art. F253-01

**Kit cornice
 luminosa e
 centralina di
 comando per
 tabellone basket**
 Ledstrip cm. 515
 Kit light frame
 and control unit
 for basketball
 backboard
 Ledstrip 515 cm.

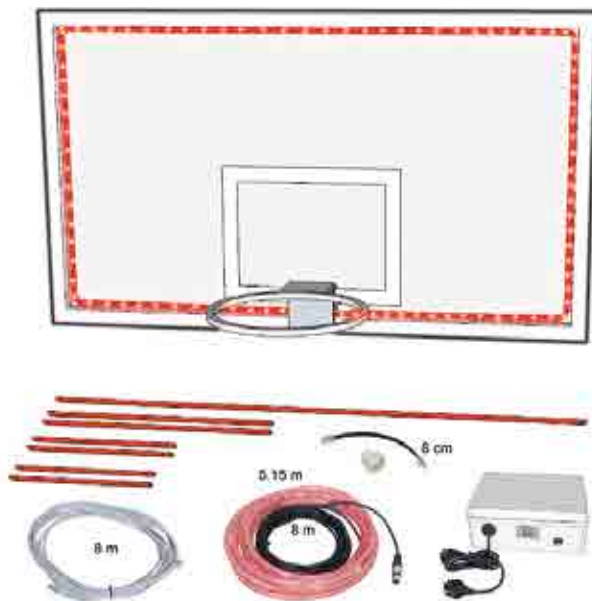

Art. F265-10

Ricevitore radio
 per utilizzo della console F230B (senza
 cavi), e per eventuale collegamento
 del tabellone indicatore
 24 secondi Art.F258-1
 alla console F230B (senza cavi)
**N.B. Per un impianto Basket completo
 occorrono no. 2 Art. F253-01 + no. 2
 Art.F258-1 + no. 2 Art.F265-10**
 Radio receiver connecting
 Art.F242 to Art.F230B, and Art.F258-1 to
 Art.F230B

TENNIS

Art. 8820G
Coppia Pali Tennis in ferro verniciato con bossole da interrare e tendirete
Tennis Posts in painted steel with underground bases

Art. 1058
Coppia Pali Tennis da fissare al pavimento in acciaio verniciato e tendirete in bronzo
Tennis Posts in painted steel for ground fixing

Art. 1059
Coppia Pali Tennis da fissare al pavimento in alluminio e tendirete in bronzo,
Tennis Posts in aluminium for ground fixing

Art. 1056
Coppia Pali Tennis in acciaio zincato e verniciato con bossole da interrare e tendirete in bronzo
Tennis Posts in galvanized and painted steel with underground bases

Art. 8819G
Coppia Pali Tennis in alluminio con bossole da interrare e tendirete in bronzo
Tennis Posts in aluminium with underground bases

pg.41

New!



Art. T030
Rete Tennis annodata m. 12,80 x 1
Tennis knotted net



Art. RT1
Centro rete
Net central holder



Art. T040
Rete Tennis da gara annodata modello Wimbledon m. 12,80 x 1
Tennis knotted match net



Art. TE10030
Impianto Junior Tennis cm. 500x100 in acciaio trasportabile (rete esclusa)
Transportable junior tennis posts in steel (net not included)



Art. TE10018
Coppia paletti per singolo in acciaio verniciato
Pair of steel poles for single



Art. 1066
Seggiolone per arbitro verniciato
Painted referee's Chair



Art. S04862
Impianto Tennis in acciaio zincato trasportabile (rete esclusa)
Transportable tennis posts in galvanized steel (net not included)

Art. 39907
Racchetta Tennis Junior con fodero e 2 palline
 Junior Tennis racket



pg.41

pg.42



Art. 44.045
Ultra thin Grip

Art. 39899
Racchetta Tennis con fodero
 Tennis racket



Art. AGDP
Tubo 3 palle tennis depressurizzate Dunlop
 Set 3 depressurized Tennis balls



Art. E6620
Paio Polsini tergisudore
 altezza cm. 7
 Pair of Wrist bands



Art. E6610
Fascia tergisudore
 altezza cm. 5
 Headband



Art. 07861
Set 3 palline gomma piuma
 Set 3 foam rubber tennis balls



Art. T4D
Tubo 4 Palle Tennis Dunlop Omologate ITF
 Set 4 Tennis Balls



Art. 48018
Racchetta Beach Tennis in resina (il colore ed il disegno possono variare)
 Beach Tennis racket



BEACH TENNIS

Art. PT41
Pallina Beach Tennis
 Beach Tennis ball



Art. P210
Rete Beach Tennis con fettuccia su tutto il perimetro
 Beach Tennis net





Art. TE18002
Cesto contenitore e raccogli palle con ruote
 Basket for picking up tennis balls



Art. TE22040
Macchina lancia palline
 velocità max 130 km/h
 velocità min. 32 km/h
 frequenza lancio da 2 a 12 secondi
 Ball throwing machine

New!



Art. TE51.04
Rullo in acciaio con racla
 Levelling roller

pg.41

pg.42



Art. RT3
Rotolo m. 150 strisce segnacampo Tennis in PVC mm. 50
 150 m. set tennis lines in Pvc



Art. RT10
Stuoia livellatrice per campi in terra battuta
 Levelling net

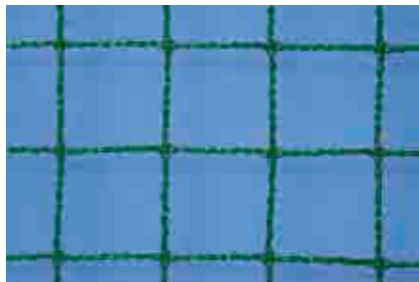

Art. 0934LR
Rete protezione polietilene verde maglia cm. 4,5x4,5 sp. mm. 2
 Protection Net green polyetilene mesh 4,5x4,5 cm. thick 2 mm.

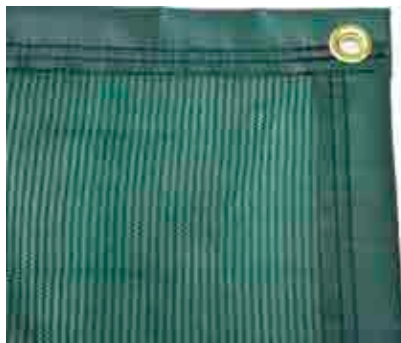

Art. 40 - 40/S - 41 - 41/S
Telo fondo campo tennis densità 90% o 70% mt.18x2 con o senza banda di rinforzo
 Tennis perimetral net density 90% or 70% dim. 18x2 meters



Art. TE53083
Tabellone segnapunti tennis cm. 100x77 h. cifre cm. 12 completo di agganci per la recinzione
 Tennis scoreboard 100x77 cm.



Art. F166PST
Tabellone elettronico portatile da tavolo per Tennis
 Portable Tennis electronic scoreboard

TENNIS TAVOLO Table-Tennis



Art. 568001
Racchetta Ping Pong Match
 Match table tennis bat



Art. 17351
Set Ping Pong 2 racchette e 3 palline
 Set with 2 bats and 3 balls



Art. 48439
Racchetta Ping Pong Expert
 Expert table tennis bat



Art. 48441
Confezione 6 Palline
 Set of 6 table tennis balls



Art. 48329
Racchetta Stiga modello Alero 2 stelle
 (disponibile fino ad esaurimento scorte)
 Stiga Alero table tennis bat
 (until available in stock)

pg.43

Art. 581561
Racchetta Stiga Stealth
 Stiga Stealth table tennis bat



Art. 17883
Confezione 144 Palline colore bianco o arancio
 Set of 144 table tennis balls



Art. 17362
Confezione 3 Palline Stiga 3 Star ITTF
 Set of 3 table tennis Stiga balls



Art. PP50
Rete in polietilene
 Net



Art. 48448
Set rete + paletti
 Net + holder



Art. PPP30
Segnapunti per Tennis Tavolo numeri da 0 a 30 rinforzati
 Table tennis scoreboard



Art. TEC.I
Tennis tavolo Tectonic indoor
per interno
Indoor Table Tennis Tectonic

pg.43

Art. TEC.O
Tennis tavolo Tectonic outdoor
per esterno
Outdoor Table Tennis Tectonic



Art. C200.O
Tennis tavolo Cornilleau modello 200 da esterno
Outdoor Table Tennis Cornilleau 200



pg.43

**Tutti i tavoli sono pieghevoli
e su ruote**
All models are foldable
and on wheels



● I numeri gialli indicano la pagina di riferimento del Listino Prezzi 2013-2014

Art. C300.I

Tennis tavolo Cornilleau

modello 300 da interno

Indoor Table Tennis Cornilleau 300

Art. C300.O

Tennis tavolo Cornilleau modello 300 da esterno

Outdoor Table Tennis Cornilleau 300



pg.43

Art. C500.I

Tennis tavolo Cornilleau

modello 500 da interno

Indoor Table Tennis Cornilleau 500

Art. C500.O

Tennis tavolo Cornilleau

modello 500 da esterno

Outdoor Table Tennis Cornilleau 500



● I numeri gialli indicano la pagina di riferimento del Listino Prezzi

BADMINTON



Art. P160
Rete
Badminton
cm. 610x70
Net

V7700
Impianto badminton
in acciaio verniciato
zavorrato, su ruote, con tendirete
(rete esclusa)
Badminton set (net not included)



pg.45

Art. 23461
Racchetta Badminton
in acciaio / alluminio
Badminton Racket
in steel / aluminium

Art. PAC12
Racchetta Badminton
in grafite / alluminio
Badminton Racket
in graphite / aluminium



Art. 22309
Volani
Badminton
completamente
in plastica
Plastic
Shuttlecocks

Art. AS85
Volani
Badminton
punta in
sughero
Cork tip
Shuttlecocks



Art. JIN
Impianto Badminton
telescopico portatile
completo
di rete e borsa
Portable badminton
set with net and bag



RUGBY



Art. 8836G1 / 8836G
Coppia Pali Rugby
in alluminio verniciato
m. 11 / m. 9,6 fuori terra
Rugby Posts
in painted aluminium



Art. 34721
Pallone Rugby
in pelle sintetica
Rugby training ball
in synthetic leather



Art. 18394
Pallone football americano
gomma-nylon



Art. V71
Pallone mini-rugby Trial
in gomma monostrato
gr. 350 dim. cm.15/27
Trial rubber Mini-Rugby Ball
single stratum

pg.44

Art. ULT71
Pallone mini-rugby Trial
in gomma doppio strato
gr.350 dim. cm.15/27
Trial rubber Mini-Rugby Ball
double stratum



Art. ULT70
Pallone rugby Trial
in gomma doppio strato
gr. 450 dim. cm.19/28
Trial rubber Rugby Ball
double stratum



Art. 6M18
Tacchetti rugby mm.18
in alluminio
Aluminium studs 18 mm.



Disponibile anche
Scudo con imbottitura
Also available
rugby shield

Art. 993156/993157/993162
Protezione imbottita per
montante porta rugby
h. cm. 200, modello
quadrato oppure tondo
Soft Protection for rugby
goal post, square and round
shape, height 200 cm.

Art. 993164
Copri bandierina
cm.10x10x100 h.
Protection for rugby flag
pole, 10x10x100 cm.



pg.45



Art. 993151/993153JR
Sacco placcaggio rugby h.
cm.140 o cm.120 diam. cm. 45
o cm. 35 con 3 maniglie
Sac for Tackling
height 140 or 120 cm.
diameter 45 or 35 cm.
with 3 handles

PISCINA-Swimming Pool



Art. E1901
Cuffia in poliestere
Polyester cap



Art. E1904
Cuffia in Lycra
Lycra cap



Art. E1127
Cuffia in silicone
Silicone cap



Art. E2607
Stringinaso con cuscini in silicone
Silicone nose-clip

pg.43

pg.44



Art. E2608
Tappi auricolari in silicone automodellanti - Set da 4 pz.
Silicone auricular plugs



Art. E2620
Occhialini da piscina Junior
Junior glasses



Art. E2615
Occhialini da piscina adulto antifog guarnizione a ventosa
Senior antifog glasses



Art. E2618
Occhialini da piscina adulto antifog monosciocca morbida
Senior soft antifog glasses



Art. E2641
Ostacolatore monoblocco
cm.15x22x7,5



Art. E2640
Tavoletta per piscina bambino
cm.37x27x3,5
Junior board



Art. E2638
Tavoletta per piscina adulto professionale
cm.35x51x4
Senior professional board



Art. E2650
Paio palette palmari forate
cm.21x16 (misura S, M, L)



Art. E2660
Copriscarpe in Pvc
set da 2000 pezzi - misura unica



Art. E2635
Paio manicotti doppia valvola
misura unica
Brackets



Art. E848
Marsupio per nuoto potenziato
Swimming pouch



Art. E845
Paracadute per nuoto potenziato
Swimming parachute



Art. E482
Paio polsiere / cavigliere per acquagym mis. cm.62x11x2
Acquagym wrist/ankle supports



Art. E851
Elastico per nuoto trattenuto - mt. 12

Art. E483
Paio manubri per acquagym cm.30 - diam.cm.14
Acquagym dumbbells



Art. E474
Paio clavette per acquagym



Art. E484
Cintura per acquagym cm.67x29x4
Acquagym belt



Art. E470
Cilindro in materiale espanso per Acquagym cm. 160 ø cm. 7

Art. E480/1
Connettore per cilindro mis. cm.14 - 2 fori

Art. E860
Contasecondi multiplo 4 lancette m. 1x1 angolazione visiva 150°



Art. E479/3
Zattera in espanso forata dim. cm.200x100x3

pg.43 pg.44

PALLANUOTO Waterpolo

Art. PPNR
Coppia Porte da pallanuoto per partite ufficiali
Pair of Waterpolo Goals

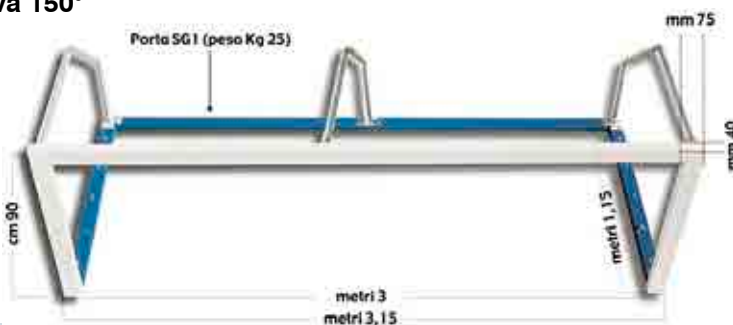

Art. SG01/SG02/SG03
Set galleggianti per corsie piscina e area gioco pallanuoto
Floating accessories for Waterpolo bounds and lanes



Art. 175P Coppia reti per porte pallanuoto
Waterpolo Nets



Art. 30415
Set cuffie pallanuoto - colore bianco o blu con numero - set 14 pz. Waterpolo caps with numbers



Art. E80
Pallone per pallanuoto Trial in Eva gr. 420 Ø 21 cm.
Waterpolo Trial ball in Eva

Art. E6890
Pallone per pallanuoto
Waterpolo Ball



HOCKEY

pg.44



Art. S05128
**Coppia porte per Hockey su pista
in acciaio verniciato**
Pair of Hockey Goals in painted steel

Art. S05122
**Coppia porte per Hockey su prato
in legno e acciaio verniciato**
Pair of Hockey Goals in wood
and painted steel



Art. S05134
**Set Unihockey composto
da 6+6 bastoni e 3 palline**

Set Unihockey made of 12 sticks and 3 balls

Art. H1
**Coppia RETI per porte da hockey pista
(indoor) in polipropilene maglia mm.45
cm.300x200x100x100**
Pair of Track Hockey Goal nets

Art. H2
**Coppia RETI per porte da hockey
ghiaccio in polipropilene complete di rete
di sbarramento, maglia
mm.20 - cm.193x122x75x120**
Pair of Ice Hockey Goal nets

Art. H3
**Coppia RETI per porte da hockey
prato in polipropilene complete di rete
di sbarramento, maglia
mm.45 - cm.366x214x90x122**
Pair of Field Hockey Goal nets

Art. H4
**Coppia RETI per porte da hockey rotelle in
polipropilene complete di rete di sbarramento,
maglia mm.20 - cm.185x122x74x110**
Pair of Roller Hockey Goal nets

BASEBALL



Art. TMB01
Mazza Baseball supersoft Trial
 lunghezza cm.71 diametro cm.4/5
 peso gr.460
 Supersoft Trial baseball bat



Art. 31713
Guanto Baseball PU senior
 Senior baseball glove



Art. 31672
Mazza Baseball senior cm.82 in legno
 Senior wooden baseball bat

New!

Art. 256151
Mazza Baseball senior in alluminio
 Senior aluminium baseball bat

pg.45



Art. 31683
Palla Baseball
 Baseball ball



Art. 31688
Palla Softball training
 Softball training ball



Art. 31703
Set mazza junior + guanto junior + palla + guantino
 Set junior bat + junior gloves + ball

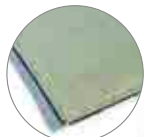

appoggio antiscivolo



imbottitura interna



Art. P21006
Set basi didattiche anti scivolo colorate
 Set of didactic antiskid bases

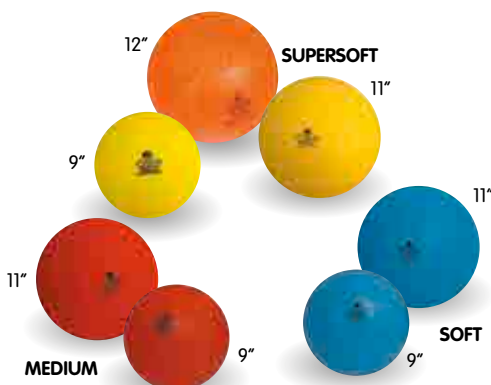

Art. BSB.8
Set 7 Palle baseball/softball Trial in gomma super soft
 diametri e grammature assortiti
 Set of Trial baseball/softball balls



Art. T21063
Batting tee Trial supersoft
 altezza regolabile da cm. 65 a cm. 86
 base diametro cm. 20,5
 peso Kg. 3
 Trial Batting tee adjustable height



BOXE



Art. 992030
Sacco Boxe in vinile
Kg. 30
Vinyl boxing bag kg.30



Art. 992040
Sacco Boxe in vinile
Kg. 38



Art. 992050
Sacco Boxe in vinile
Kg. 45



Art. 993003
Gancio Ammortizzatore
per sacco boxe
Spring for boxing bag

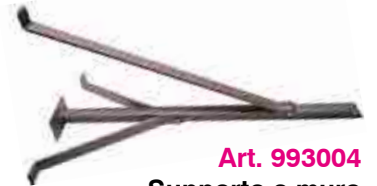

Art. 993004
Supporto a muro
per sacco boxe
Iron wall support for
boxing bag



Art. 992804
Sacco Boxe
con pedana
riempibile
con acqua o
sabbia, altezza
regolabile
(max cm. 220)
Freestanding
bag adjustable
height



Art. 992840
Sacco Boxe
basculante
h. cm. 170
zavorrabile con
sacchi di sabbia
(inclusi)
Self-Straightening
boxing bag
height cm.170



Art. 45018
Pera montata
su mensola
Speed bag kit

pg.52

pg.53



Art. 45361
Punching
ball su
supporto
a terra
Punching
ball



Art. 17220
Casco Boxe
misure S,M,L,XL

New!

Art. 44613A
Set protezioni
parastinco +
parapiede
misure S/M/L/XL
Shin/foot protections



Art. 14602A
Paio guanti
da passata
misure M e L



Art. 17213
Guanti da Sacco
in PU (S-M-L-XL)
Bag gloves

New!



Art. 6206
Guanti da Sacco
in pelle (S-M-L-XL)
(disponibili fino
ad esaurimento
scorte)

pg.53



Art. 21796
Guanti Fit-Boxe
size S-M-L-XL
Fit-Boxing gloves



Art. 17211
Coppia Fasce boxe
Boxing bandages



Art. 74613A
Guanti MMA in PU
Taglie S-M-L-XL
MMA gloves

New!



Art. 93602A
Guanti Boxe
in pelle
per combattimento
non omologati
8/10/12 oz.
Leather boxing gloves



Art. GBL10T
Guanti Boxe
Leone in pelle
10 oz.
Leone Boxing
gloves

ARTI MARZIALI - Martial Arts



pg.53

Art. 24772
Divisa judo con cintura
misure dalla 00 (cm.120)
alla 7 (cm.200)
Judo strip with belt

Art. 24773
Divisa karate con cintura
misure dalla 00 (cm.120)
alla 7 (cm.200)
Karate strip with belt



Art. 23271
Cintura judo / karate 100% cotone
colori : nero, blu, arancio, marrone,
verde, giallo, bicolore giallo-bianco
misure dalla 2 alla 6 Judo / Karate belt



Art. F162
Tabellone elettronico
portatile da tavolo
per Karate
Karate portable
electronic
Scoreboard



Art. F164
Tabellone elettronico
portatile da tavolo
per Judo
Judo portable
electronic
Scoreboard



TATAMI

pg.53



TX-RIN

TATAMI "Ring" cm.100x100x1 densità 120 Kg/mc non reversibile - in EVA colore blu
prezzo incluso bordo protettivo perimetrale
Tatami soft flooring in Eva 100x100x1 cm.
density 120 Kg/mc blue color
perimetral frame included



TX-K20

TATAMI Karate K20
cm.100x100x2
ad incastro, bicolore,
reversibile, in polietilene
espanso reticolato
prezzo incluso bordo
protettivo perimetrale
colori: verde/rosso,
rosso/blu

TATAMI K20 100x100x2 cm.
bicolor, reversible
perimetral frame included
colors: red/green, red/blue



TX-J40

TATAMI Judo J40
cm. 100x100x4 ad incastro,
bicolore,
reversibile, in polietilene
espanso reticolato
prezzo incluso bordo
protettivo perimetrale
colori: verde/bianco/rosso,
giallo/bianco/blu

TATAMI J40 100x100x4 cm.
3 colors, reversible
perimetral frame included
colors : red/green/white,
yellow/white/blue

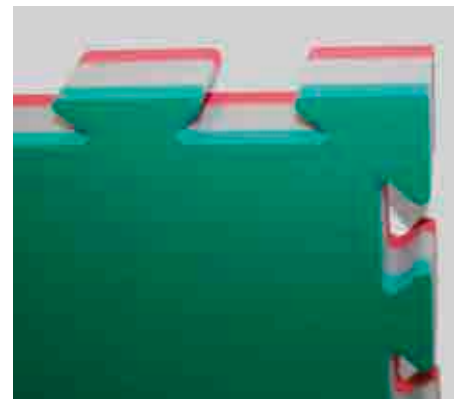
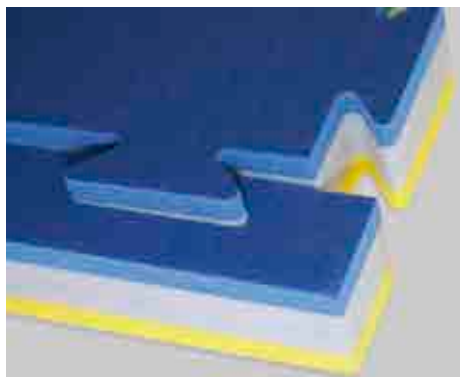

TX-2010

TATAMI tradizionale
cm. 200x100x4 in PU
Densità 230 Kg/mc
rivestito in Pvc
con fondo anti scivolo
colori: blu, verde, rosso, giallo
TATAMI 200x100x4 cm.
in PU density 230 Kg/mc
cover with anti skid pvc stratum
colors: blue, green, red, yellow



PROTEZIONI MURARIE

pg.45 pg.46

Wall protections

Art. B2085 / B2066

Protezione muraria e per colonna
vari spessori in PE espanso alta densità,
fissaggio con occhielli o velcro

per interno ed esterno (su preventivo)
Wall and column protections
various thickness for indoor
and outdoor



Protezioni a strisce
e angolari per spigoli
(vedere listino prezzi)
Also available stripe and
edge protections

MATERASSI - TAPPETI - MATS



Art. B2001/ ... /B2016

Materassi di caduta realizzati
con fodera di rivestimento
in Pvc antimuffa, antibatterica,
ignifuga Cl.2 con imbottitura in
gommapiuma di varie densità
(vedere listino per le dimensioni)
Mats of various dimension and
thickness

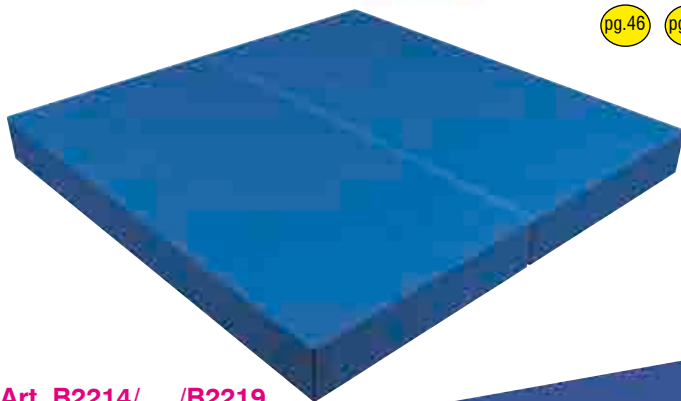

pg.46 pg.47



Particolare Art. B2014/B2015/B2016

Art. B2214/ ... /B2219

Materassi Pieghevoli
di caduta

Foldable Mats

Art. B2228/ ... /B2231

Tappeti Gym Mat dim.
cm.200x100
spessore cm.3/4/5/6
ad alta densità
in polietilene
a cellule chiuse
(per uscita attrezzi)

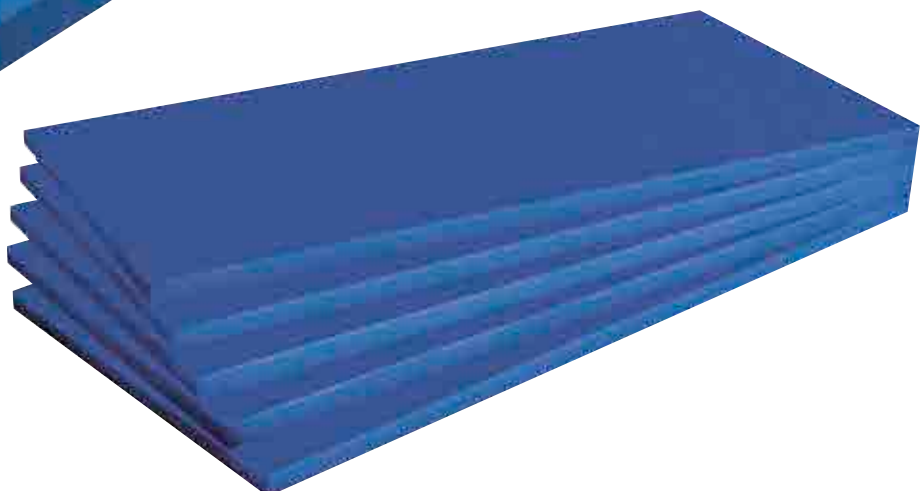

GINNASTICA - Gymnastic



Art. S00352

**Armadio porta attrezzi con vano portavalori
a 4 ripiani in lamiera
dimensioni cm. 100x45x200 h.
Equipment locker with safe-deposit box**

pg.47



Art. S00354

**Armadio porta attrezzi a 4 ripiani
in lamiera dimensioni cm. 100x45x200 h.
Equipment locker**



Art. S00356

**Armadio porta attrezzi
in lamiera dimensioni
cm. 120x45x200 h.
a 4 ripiani
e porte scorrevoli
Equipment locker with
sliding doors**

pg.47

Art. S00362
**Mobile porta attrezzi su ruote
Equipment trolley on wheels**

pg.22

Art. V1048
**Armadio in rete con
maniglioni e ruote
telaio in acciaio
dimensioni
cm. 150x75x160 h.
Equipment locker
on wheels**





Art. S00304
Coppia ceppi Baumann in legno
Pair of Baumann blocks in wood

Art. S00302
Coppia appoggi Baumann in legno
Pair of Baumann supports in wood

Art. S00002
Coppia anelli in legno lamellare
Pair of wood rings



pg.47

pg.48

pg.49

Art. S00018
Confezione da 8 pani magnesio gr. 55
Chalk blocks



Art. S00512
Mensola porta clavette



Art. E8000
Paio scarpette in pelle per ginnastica ritmica
taglie da 26 a 46
Pair of shoes for rhythmic gym
color black or white



Art. CS5
Corda salto per ritmica
m. 3
Jumping rope

Art. P00510/S00502/S00508
Coppia clavette in nylon, in legno a collo lungo e collo corto
Wooden and plastic clubs



Art. P01210
Nastro per ginnastica ritmica m. 6
Rhythmic Gym streamers



Art. CS7
Corda salto per ritmica
m. 3 piombata
Jumping rope weighted



Art. S01624
Specchio quadrettato con cornice in legno da fissare a parete
(misure a richiesta)
Wall mirror with wooden frame



Art. S01606
Supporto per sbarra regolabile da fissare a parete
 Support for bar to be fixed on the wall

Art. S01608
Supporto per sbarra regolabile da fissare a terra
 Support for bar to be fixed on the floor



Art. 1156TE
Supporto per sbarra regolabile da cm. 78 a cm. 140 in acciaio con base autoportante economica
 Cheap freestanding support for bar



Art. S01602
Sbarra per danza in legno (pezzo unico fino a 4 metri)
 Wooden bar

Art. 1156/T
Supporto per sbarra regolabile da cm. 78 a cm. 140 in acciaio con base autoportante
 Freestanding support for bar

pg.48 pg.49

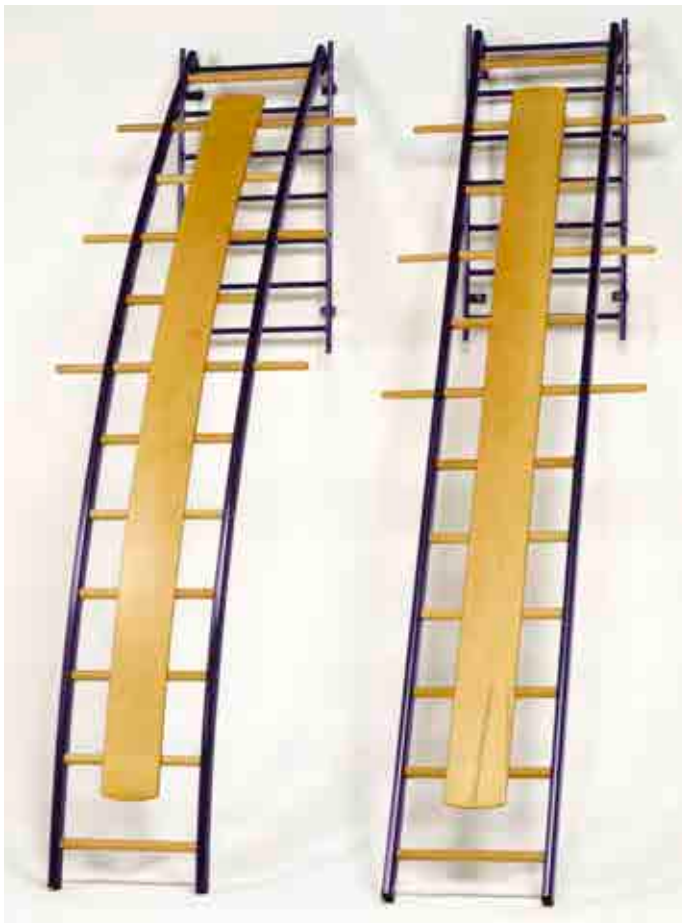

Art. S01052 / S01054 / S01060 / S01062
Scale ortopediche dritte o curve, a parete o trasportabili
 Orthopaedic ladders



Art. S00754 / S00756
Palchi di salita Climbing apparatus



Art. S00056 / S00058 / S00052
Assi di equilibrio ad altezza fissa e graduabile
Balance beams adjustable and fixed height

pg.47

pg.48

pg.49



Art. S00060 / S00064
Trave di equilibrio in alluminio rivestito lungh.mt.5 altezza regolabile (a norme F.I.G.) oppure ad altezza fissa
Balance beam 5 meters adjustable height 50-120 cm. or fixed height



Art. S00204/S00206/S00208/S00210
Pedane elastiche con piano di battuta in legno, ricoperto in gomma, ricoperto in moquette o a doppio molleggio
Springboards



Art. S00104
Cavallo per volteggio senza maniglie rivestito in cuoio sintetico altezza regolabile
Vaulting buck adjustable height



Art. V1168
Cavallina regolamentare rivestita in cuoio sintetico altezza regolabile da cm. 90 a cm.130
Vaulting buck adjustable height



Art.S00220
Tappeto arrotolabile per pedana corpo libero in poliuretano e moquette, rotolo da m. 15
Gymnastic moquette floor, roll m. 15 long



pg.12

Art. S00914/S00918/S00920
Panche svedesi
Swedish benches



Art. S00252
Sbarra orizzontale
per volteggi regolabile in
altezza, fissaggio
a terra con tiranti
Vaulting bar adjustable height



Art. S00160
Parallela Scolastica a losanga
ad altezza fissa, staggi in legno lamellare
Scholastic parallels fixed height



● pg.48 ● pg.49

Art. S00156
Parallela Asimmetrica Femminile in acciaio verniciato
su basamento pesante, montanti graduabili,
staggi in legno lamellare regolabili in altezza e larghezza
Asymmetrical bars adjustable height



Art.S00152
Parallela Maschile in acciaio verniciato
su basamento pesante, montanti graduabili,
staggi in legno lamellare
regolabili in altezza e larghezza
Parallels bars adjustable height

ATLETICA - Track & Field



Art. PBS-SI
Blocco di partenza da allenamento in acciaio zincato
Starting Blocks in galvanized steel



Art. BL01
Paio Blocchi di partenza in gomma per palestra
Pair of gym Starting Blocks in rubber for beginners



Art.S02010/PPA38
Testimoni per staffetta in pvc o omologati in alluminio
Pvc or aluminium relay baton



Art. 500013/PG2
Pettorali in stoffa per gare atletica
Numbers for competitions

pg.49

pg.50



Art. S02112
Megafono a transistor portatile
Handy megaphone



Art. F601
Ostacolo per Atletica in ferro zincato graduabile cm. 50-60-76,2
Adjustable height hurdle in galvanized steel



Art. S02126
Pistola a tamburo per starter
starter's revolver gun



Art. F602
Ostacolo per Atletica in ferro zincato graduabile cm. 76,2-84-91,4
Adjustable height hurdle in galvanized steel

Art. S02072
Ostacolo per Atletica in alluminio anodizzato graduabile cm. 76,2-84-91,4-100-106,7 omologato I.A.A.F.
Adjustable height hurdle in anodized aluminium according to I.A.A.F. standards



Art. S02064
Ostacolo per Atletica in acciaio graduabile cm. 76,2-84-91,4-100-106,7
Adjustable height hurdle in steel



Art. VSH-222
Ostacolo per Atletica Vinex olimpionico in ferro zincato omologato IAAF
Adjustable height hurdle in galvanized steel according to I.A.A.F. standards

New!



Art. S02552
Coppia ritti salto in alto scolastici altezza cm.200
Scholastic High Jump height 200 cm.



Art. S02554
Coppia ritti salto in alto in acciaio zincato scolastici altezza cm.230
Scholastic High Jump height 230 cm.



Art. S02556
Coppia ritti salto in alto in acciaio zincato periscopici h. cm. 250
High Jump height 250 cm.



Art. S02558
Coppia ritti salto in alto periscopici in acciaio zincato da competizione h. cm. 260
Competition High Jump height 260 cm.



Art. S02584
Piattaforma zincata di sostegno e sollevamento area caduta
Galvanized steel support platform for landing area

pg.52

Art. B2080/B2081/B2082
Zone di caduta salto in alto
High Jump landing mats



Art. S02566
Asta segnalimite in PTE per salto in alto
High Jump crossbar with soft PTE cylinders



Art. S02602
Coppia ritti per salto con l'asta in alluminio graduabili fino a cm. 650
Pair of aluminium pole vault stands

Art. B2077/B2078
Zone di caduta salto con l'asta
Pole vault landing mats



Art. S02568 / S02570
Asta segnalimite per salto in alto m. 4 in alluminio o vetroresina
High Jump aluminium or fiberglass crossbar



Art. VT08/ ... /VT15
Palle lancio
in gomma Trial,
varie grammature
Trial rubber throwing balls



Art. VDL5/ ... /VDL72
Palle getto anelastiche
in gomma per indoor,
varie grammature
Trial shot balls
in rubber for indoor



Art. S02486/ ... /S02496
Palle getto in metallo verniciato
tarate, varie grammature
Metal shot balls



Art. S02510
Pedana per lancio del peso
in acciaio zincato
Galvanized steel shot put throwing circle

pg.51

pg.52

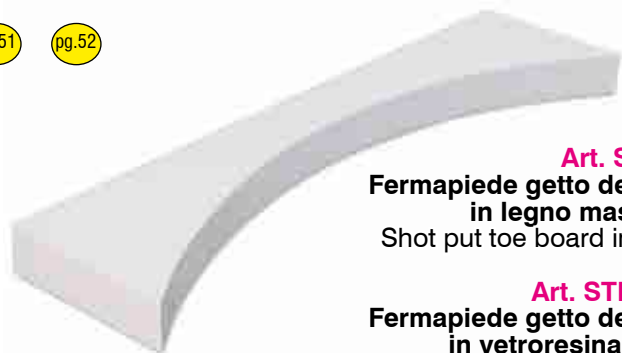

Art. S02512
Fermapiede getto del peso
in legno massiccio
Shot put toe board in wood

Art. STB-F100
Fermapiede getto del peso
in vetroresina - IAAF
Shot put toe board in fiberglass - IAAF

New!



pg.50

Art. VVS-100
Podio vincitori in metallo verniciato,
piano in laminato - impilabile
Painted Iron Podium



Art. P15020
Pedana Lancio in neoprene espanso
per allenamento lancio disco, giavellotto, peso,
martello e salto in lungo
Training toe board

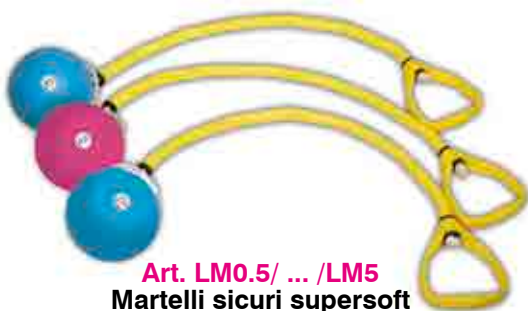

Art. LM0.5/ ... /LM5
Martelli sicuri supersoft
in gomma Trial
varie grammature
Supersoft Trial hammers



Art. PM3/ ... /PM726
Martelli in acciaio da allenamento Polanik
Steel hammers



Art. DSK1/ ... /DSK2
Dischi in gomma Trial varie grammature
 Discus in rubber Trial



Dischi Jet speciali per avviamento al lancio con peso distribuito sulla parte esterna per favorire la penetrazione nell'aria
 Special Jet discus with weight distributed mainly on the external perimeter in order to increase air penetration

Art. JET03/JET05/JET1
Dischi Jet in gomma
 Trial Kg. 0,3/0,5/1

pg.50



Art. DT0.4/ ... /DT1
Dischi Trial a 3 impugnature in gomma approvati IAAF per attività scolastica
 Trial discus approved by IAAF for school training

Art. W4T/ ... /W8T
Giavellotti Polanik in lega leggera puntale acciaio
 gr. 400/500/600/700/800
 Polanik Javelins in light alloy with steel edge in various weights



Art. TPD075/ ... /TPD2
Dischi in plastica bordati in acciaio Polanik
 Discus in plastic-steel



Art. CPD1/ ... /CPD2
Dischi in nylon bordati in acciaio Polanik - omologati IAAF
 Discus in nylon-steel



Art. JAL-C400/ ... / JAL-C800
Giavellotti Vinex in lega leggera, puntale in acciaio
 gr. 400/ ... /800
 Vinex Javelins in light alloy, with steel edge weight gr.400/ ... /800



Art. TRTJ
Turbo Jav per avviamento al lancio
 Turbo Jav for throwing introduction

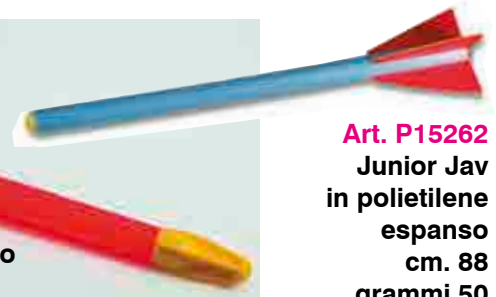

Art. P15262
Junior Jav in polietilene espanso
 cm. 88
 grammi 50



Art. VMH
Vortex per avviamento al lancio del giavellotto e per football americano
 Vortex for throwing introduction

Art. VMH.J
Mini Vortex gr. 40 lunghezza cm. 17

PILATES



Art. EVA.P
Mattoncino pilates in eva
Block for pilates



Art. MPS50
Mattoncino
pilates gonfiabile
Trial soft gr. 500
cm.11,3x24x5,5h
Inflatable block for pilates



pg.54

Art. MPS30
Mattoncino
pilates gonfiabile
Trial soft gr. 250
cm.12x24x3,5h
Inflatable block for pilates



Art. BA4
Palla tender per pilates
ø cm. 20 - gr. 180
super soffice e sicura
Trial rubber tender ball
for pilates



New!

Art. T.TWIN
Coppia Twin balls
ø cm. 9,2 - gr. 180
Trial rubber Twin balls
for pilates

Utilizzate nella
bioginnastica, pilates e
ginnastica dolce, per la
riflessologia non solo
plantare, per il rinforzo,
riattivazione circolatoria
e rilassamento muscolare

New!



Art. 995025
Cilindro pieno
Foam roll
cm. 90x15
Not inflatable



Art. FY9512
Fitball roller
gonfiabile
diametro cm. 18
Inflatable



Art. TR38
Toning ring



pg.54

Art. TBS1
Palla Boa autobilanciante
in gomma Trial - oscilla ma torna al suo posto
senza rotolare via - stabile, ideale
per correggere la postura
range utilizzo cm. 50-60 peso kg. 1,5
Trial rubber Boa Ball swings but comes back
to its original position
very good for postural therapy



DIDATTICA SCOLASTICA



Art. BA1

Air Ball Trial Ø cm. 12 gr. 100
morbida e rimbalzante
(ideale anche per pallapugno)
Trial Air Ball



Art. M13828

Pallapugno FIPAP
diametro cm. 11
peso grammi 60
FIPAP pallapugno



Art. M506

Guanto da gioco per pallapugno
Pallapugno glove



Art. ST14

Palla Canguro Ø cm. 45
Trial Cangaroo Ball

pg.54



Art. ST15

Palla Canguro Ø cm. 55
Trial Cangaroo Ball



Art. ST16

Palla Canguro Ø cm. 65
Trial Cangaroo Ball



New!

Art. BTST12

Set 6+6 bocce supersoft
con pallino e borsa
Set of 12 supersoft
bowls with bag



Art. P18110

Tamburello indoor
diametro cm. 26
(fino a 13 anni)
omologato FIPT
FIPT indoor
tamburello Ø cm. 26



Art. P18112

Pallina per tamburello
depressurizzata
indoor diametro cm. 6,5
grammi 40
Tamburello indoor depressurized ball



Art. P18111

Tamburello indoor
diametro cm. 28
omologato FIPT
FIPT indoor tamburello
Ø cm. 28



Art. S00552 - S00556
Funne per tiro alla funne
lunghezza m. 15 o m. 25
con indicazioni colorate
Rope for tug of war
length 15 or 25 meters



Art. I-059

Set 10 mattoncini dritti
cm. 25x16x13h
 Set of 10 straight bricks



Art. I-060

Set 10 mattoncini curvi
cm. 22x16x13h
 Set of 10 curved bricks



Art. I-098

Blocco percorso
cm. 30x15x10h
 Block for route



Art. PCAD

Paracadute Ø cm. 300
 Parachute

pg.54



Art. I-061

Percorso equilibrio composto da
5 assi + 6 mattoncini + 24 ventose



Art. S00794

pg.48

Pannello per arrampicata in legno
agganciabile a spalliera o quadro
svedese Climbing board



Dodgeball
Palla
Avvelenata



Art. TDB16

Palla per Dodgeball diametro cm. 16
peso grammi 210 colore arancio fluo
 Dodgeball Ø cm. 16

Art. TDB20

Palla per Dodgeball diametro cm. 20
peso grammi 230 colore giallo fluo





Art. 801171
Skateboard Junior



Art. 510271
Skateboard Senior



Art. 705781
Pattino in line allungabile Junior
Taglie: 30/33 - 34/37 - 38/41
In line skate adjustable size



Art. 055171
Pattino in line
Taglie dalla 36 alla 46
In line skate

pg.54



Art. 41168
Casco Skate
taglie S-M-L
Skate helmet



Art. 681171
Set 3 protezioni Junior
misure S-M-L

Art. 132171
Set 3 protezioni Senior
misure da S a XL
Junior and Senior protections



Art. 533171
Monopattino A120
Scooter

Art. 25333A
Frisbee
diametro cm. 27,5
Frisbee



Art. 45119
Set racchette da spiaggia in legno con palla
Set of Beach Fun Rackets



BARRET®

ATTREZZATURE PER L'ALLENAMENTO DEI CAMPIONI
TRAINING TOOLS FOR CHAMPIONS



BARRET s.r.l.

Via Marie Curie, 6/8
Zona Ind.le S. Pietro in Palazzi
57023 CECINA (LI) - Italy
telefono (+39) 0586.661215
fax (+39) 0586.662417
E-mail: info@barretsport.com
www.barretsport.com